

2023 Vol 2.0

To Make Your Embedded Idea a Reality

- Network Security Appliance
- Autonomous Driving Controller
- In-Vehicle Computer
- Embedded Boards



Company Profile

Founded in 1987, Acrosser is a pioneer in the evolution of industrial computing. For several decades, Acrosser has provided innovative embedded computer solutions and quality products to thousands of customers, helping them reduce the time-to-market and gaining higher competence to win the market.



Business Scope



Wide Array of Standard Industrial PC Products

ACROSSER designs a wide range of off-the-shelf Single Board Computer products following the international open standard, such as Embedded PC/104(+), EPIC, Embedded ATX, Mini-ITX, Industrial ISA, PCI, PCI-Express, etc. Therefore, the qualified products provide easy-maintain, fast-upgrade, and international compatible advantages to save your upfront investment. With a broad range of products lines, ACROSSER products also perform under multiple dominant operating systems, including Windows XP, Windows 7, Windows 8, Linux, Fedora, Ubuntu, etc.



In-Depth and Versatile Applications Experience

From 1987, ACROSSER has assisted our customers in developing the embedded systems for different industries, like Networking Security, Wireless Appliance, Gaming, Medical, Industrial Automation, Surveillance, POS, KIOSK, Digital Signage, Home Automation, Instrumentation, Marine, Military, Transportation, etc. Our professional team has the vertical markets knowledge and can help customers develop the right solutions to easily pass the related certificates like FDA for Medical; GLI, Comma 6A for Gaming; FCC, CE for all products.



Top Quality Assurance with Long Life-Cycle Supply

ACROSSER has been thousands of customers' proven vendor including a lot of Fortune 500 companies. ACROSSER's 100% ESS(Environmental Stress Screen) Burning, Dynamic Vibration, and Functional test on every mass production unit help our customers to save a lot of RMA cost. As for its commitment to quality products, ACROSSER designs all products based on its Embedded Roadmap with a minimum 5 years product lifetime. Along with a very strict Revision Control System, it provides our customers with a stable, long term products supply.

ACROSSER encourages participation from all employees and believes that everyone contributes to ACROSSER's success. With "To Make Your Embedded Idea a Reality" as its Mission Statement, ACROSSER keeps its promises to all customers by constantly developing innovative solutions and providing professional OEM/ODM custom design services rapidly. In all, ACROSSER assists you and your company to become the leader in your vertical market, building a Win-Win relationship together.

Table of Contents

CPU/Chipset	Form Factor	Model No.	Page
In-Vehicle Computer			
Intel HM570E	In-Vehicle PC	AIV-TGH7B	6
Intel HM570E	In-Vehicle PC	AIV-TGH7E	8
Intel Q170	In-Vehicle PC	AIV-Q170V1FL	10
Intel Apollo Lake	In-Vehicle PC	AIV-APL1V1FL	12
Autonomous Driving Controller			
Intel W480E	Autonomous Driving Controller	AAD-W480A	18
Intel W480E	Autonomous Driving Controller	AAD-W480A1-P, AAD-W480A2-P	20
Intel W480E	Autonomous Driving Controller	AAD-W480B	22
Intel W480E	Autonomous Driving Controller	AAD-W480B1-P, AAD-W480B2-P	24
Intel PCH C622	Autonomous Driving Controller	AAD-C622A	26
Network Security Appliance			
Intel Ice lake-SP	2U Rackmount	ANR-C621A1	34
Intel Ice lake-D	1U Rackmount	ANR-ICEDA	36
Intel Comet lake Series	1U Rackmount	ANR-W480A	38
Intel Xeon E	1U Rackmount	ANR-C246E1	40
Intel Skylake/Kabylake	1U Rackmount	ANR-SKB1N	42
Intel Skylake/Kabylake	1U Rackmount	ANR-SKB2N	44
Intel Denverton Series	1U Rackmount	ANR-DNV3N3	46
Intel SoC	Desktop	AND-DNV3B	48
Intel Denverton Series	Desktop	AND-DNV3A	50
Intel Denverton Series	Desktop	AND-DNV3N1	52
Intel Denverton Series	Desktop	AND-DNV3N3	54
Intel Elkhart Lake SoC	Desktop	AND-EL6KE1	56
Intel Apollo Lake Series	Desktop	AND-APL1E	58
Embedded Boards			
Intel Atom x600E	COM Express type 10	ACM-EL6KE0	64
Intel11 th Core™ M I Processor	COM Express type 10	ACM-TGLUE0	65
Intel Xeon D	COM Express type 7	ACM-ICLDE7	66
Intel Xeon D	COM Express type 7	ACM-XD15B7	67
Intel Xeon E	COM Express type 6	ACM-XE21B6	68
Onboard DM&P Vortex86DX3	Half-Size-Card	AMB-VDX3H2	69
Intel Atom x600E	IoT Edge Embedded System	AES-EL6KA	70

In-Vehicle Computer

Acrosser In-Vehicle Computer (Car PC, Vehicle PC, On-Board Computer, Bus PC, vehicle applications, ADAS solutions, or car computer) is designed to perform multiple in-car functions, including infotainment, fleet management, telematics, video surveillance, taxi dispatch, and law enforcement. A newer unique need in the intelligent traffic system, asset management, job dispatch, video surveillance, and fuel-saving has come to the market recently.

With the compliance of ISO 7637-2 and E-Mark, Acrosser provides solid car pc solutions for its customer to shorten time-to-market. Common features of the Acrosser on-board computer include CAN Bus, GPS, GPRS/3.5G/LTE, Wi-Fi, Bluetooth, anti-shock, and anti-vibration. An Acrosser In-Vehicle computer integrates a wide range of DC input with surge protection, which resolves the critical power management issue within each vehicle. Therefore, Acrosser's car pc was embedded into multiple applications, from the taxi, police car, ambulance to firefighter truck, heavy-duty truck, bus, construction vehicle, and train.

Edge and In-Vehicle computing application

The latest wide operation temperature fanless computer for in-vehicle application and edge computing fields.



CAN Bus



POE



Wide temp



Delay Time
on/off



ANTI
VIBRATION



Server-Grade
Performance



Power
Management



Wireless



AIV-TGH7B

11th Gen Intel® Core™ i7/i5/i3
Processor(Tiger Lake)

Fanless Computer

2.5" SSD/HDD

Product Matrix

In-Vehicle Computers



Form Factor	In-Vehicle Computer	
Model Name	AIV-TGH7B	AIV-TGH7E
Specification		
CPU	Intel® 11th Generation Core™ Processor i7-11850HE / i5-11500HE / i3-11100HE	Intel® 11th Generation Core™ Processor i7-11850HE / i5-11500HE / i3-11100HE
Memory	1 DDR4 3200 SODIMM	1 DDR4 3200 SODIMM
Video		
Video Interface	1 HDMI , 2 DP	1 HDMI , 2 DP
Storage		
SATA	2 x SATA III port	2 x SATA III port
SSD	2 x swappable 2.5 inch SSD bay	2 x swappable 2.5 inch SSD bay
CF	-	-
Disk Bay	2 x Anti-shock 2.5" HDD Bay with easy swappable bracket	2 x Anti-shock 2.5" HDD Bay with easy swappable bracket
I/O		
Expansion Slot	1 x M.2 B Key(3052), 1 x M.2 M Key(2280)	1 x mini PCIe, 1 x M.2 B Key(3052)
Ethernet	-	-
Serial Port	2 DB9 Type RS-232/RS422/485 2 DB9 Type RS-232	2 DB9 Type RS-232/RS422/485 2 DB9 Type RS-232
USB	4 Type A USB 3.2 Gen2	4 Type A USB 3.2 Gen2
GPIO	-	-
Audio	1 Mic-in, 1 Line-in, 1 Line-out	1 Mic-in, 1 Line-in, 1 Line-out
Remote Control	N/A	N/A
SIM	-	-
Can Bus (2.0A/2.0B)	-	1 DB9 CANBus
Power Requirement		
Power Input	DC 9V ~ 24V with power ignition	DC 9V ~ 32V with power ignition
Software		
OS Support	Windows 10 Enterprise Linux Kernel 4.4	Windows 10 Enterprise Linux Kernel 4.4
Mechanical & Environment		
Dimension	220mm(W) x 175mm(D) x 73mm(H)	220mm(W) x 175mm(D) x 73mm(H)
Weight	TBD	TBD
Operating Temp	-40°C to 70°C (-40°F to 158°F)	-40°C to 65°C (-40°F to 149°F)
Vibration/Shock/Safety	Comply IEC 60068-2-64 / Comply IEC 60068-2-27 / CE, FCC Class B, E-Mark 13	
Optional Wireless Module		
4G	GPRS/EDGE/WCDMA/HSUPA/HSDPA	
GPS / WiFi / Bluetooth	YES, IEEE 802.11 b/g/n, YES	
Reference		
Page	6	8

Product Matrix

In-Vehicle Computers



Form Factor	In-Vehicle Computer	
Model Name	AIV-Q170V1FL	AIV-APL1V1FL
Specification		
CPU	Intel® Sky-lake-S i7-6700 TE / i5-6500 TE / i3-6100 TE	Intel® Pentium™-N4200
Memory	2 x DDR4-SO-DIMM	2 x DDR3L 1866 MHz ,SO-DIMM, support up to 8GB
Video		
Video Interface	1 x HDMI (With locking bracket) 1 x VGA 1 x DVI-D	1 x VGA port (DB15) 1 x DVI connector
Storage		
SATA	2 x SATA III port	2 x SATA III port
SSD	2 x swappable 2.5 inch SSD bay	-
CF	1 x CF	-
Disk Bay	2 x Anti-shock 2.5" HDD Bay with easy swappable bracket	2 x swappable 2.5" Disk bay with Anti-vibration/Anti-shock solution for SSD only
I/O		
Expansion Slot	3 x mini PCIe	3 x mini PCIe
Ethernet	4 x POE GbE LAN	2 x GbE RJ45, Intel i210AT
Serial Port	4 x RS232/422/485	3 x RS232 1 x RS232/422/485
USB	8 x USB 3.0	4 x USB 3.0
GPIO	4 In, 4 Out	4 In, 4 Out
Audio	1 x MIC in, 1 x Audio out	1 x MIC in, 1 x Audio out
Remote Control	1 x Remote control switch	1 x Remote control switch
SIM	2 x External SIM Slot	2 x External SIM Slot
Can Bus (2.0A/2.0B)	YES	YES
Power Requirement		
Power Input	DC 9V ~ 36V with power ignition	DC 9V ~ 36V with power ignition
Software		
OS Support	Windows 10 Enterprise Linux Kernel 4.4	Windows 10 Enterprise Linux Kernel 4.4
Mechanical & Environment		
Dimension	270 x 170 x 63 mm	260 x 195 x 63 mm
Weight	6.2 Kg	4 Kg
Operating Temp	-25 ~ 60°C (-13 ~ 140°F)	-25 ~ 60°C (32 ~ 140°F)
Vibration/Shock/Safety	Comply IEC 60068-2-64 / Comply IEC 60068-2-27 / CE, FCC Class B, E-Mark 13	
Optional Wireless Module		
4G	GPRS/EDGE/WCDMA/HSUPA/HSDPA	
GPS / WiFi / Bluetooth	YES, IEEE 802.11 b/g/n, YES	
Reference		
Page	10	12

AIV-TGH7B

11th Gen Intel® Core™ i7/i5/i3 Processor(Tiger Lake)
Fanless Computer, 9-24Vdc



Features

- Intel® 11th Generation Core™ i7/i5/i3 Processor
- Support 1 DDR4 3200 SODIMM, up to 32GB
- Support 2.5GbE, USB 3.2 Gen2 x 4
- Triple Display : HDMI 2.0b x 1 , DP++ 1.2a x 2
- Two front easy access 2.5" SATA III storage bay
- Wide Temperature design : -40~70C
- Wide Voltage Power Input : 9-24Vdc
- Fanless design

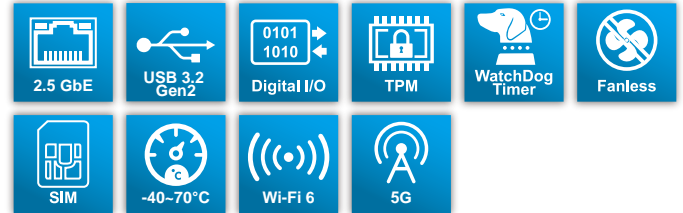

CE FCC

Others

TPM	Optional By Request
Watchdog Timer	255 Levels
Smart Management	Wake on LAN, PXE supported
HW Monitor	Monitoring temperature, voltages. Auto throttling control when CPU overheats.

Software

OS Support	Windows 10, Linux
------------	-------------------

Power Requirement

Power Input	9V to 24V, DC-in
Power Interface	3-pin Terminal Block

Mechanical & Environment

Dimension	220mm(W) x 175mm(D) x 73mm(H) (8.66" x 6.89" x 2.87")
Weight	TBD
Mounting	Wallmount
Operating Temperature	-40°C to 70°C (-40°F to 158°F)
Storage Temp	-40°C to 80°C (-40°F to 176°F)
Humidity	5% to 90% Humidity, non-condensing
Shock	IEC 60068-2-27 SSD : 50G @ wallmount, Half-sine, 11ms
Vibration	IEC 60068-2-64 SSD : 5Grms, 5Hz to 500Hz, 3 Axis
EMC	CE / FCC class A

*Please adopt wide operation temperature RAM, SSD, HDD to get better and stable system performance.

Specification

System

CPU	Intel® 11th Generation Core™ i7/i5/i3 Processor (Tiger Lake-H) i7-11850HE (8C/16T, 2.60GHz, up to 4.70GHz) i5-11500HE (6C/12T, 2.60GHz, up to 4.50GHz) i3-11100HE (4C/8T, 2.40GHz, up to 4.40GHz)
Chipset	Intel® HM570E
Memory	1 DDR4-3200 Memory supports up to 32GB (ECC)

Video

Graphic Controller	Intel® Iris® X Graphics
Interface	1 HDMI , 2 DP

Storage

SATA	2 SATA III (6Gbps) support S/W RAID 0, 1
Storage Device	2 Front-access 2.5" SSD/HDD Tray Max total current is 2A for dual SATA devices

I/O

LAN	LAN 1 : RJ45 Type Intel® I225 2.5GigE LAN LAN 2 : RJ45 Type Intel® I219 GigE LAN
Serial	2 DB9 Type RS-232/RS422/485 2 DB9 Type RS-232
USB	4 Type A USB 3.2 Gen2
DIO	16 DIO, DB25 Type connector
Audio	1 Mic-in, 1 Line-in, 1 Line-out
LED	Power, HDD, Status
Button	1 Power Press Button
Antenna Hole	6 Antenna Holes

Expansion

Mini PCIe	1 x Half Size Mini PCIe slot
M.2	1 x M.2 B Key(3052) (Default PCIe[x1]+USB3.0+USB2.0) 1 x M.2 M Key(2280) (PCIe 4.0[x4])
SIM Slot	1 Nano SIM Slot (Internal)

Dimension

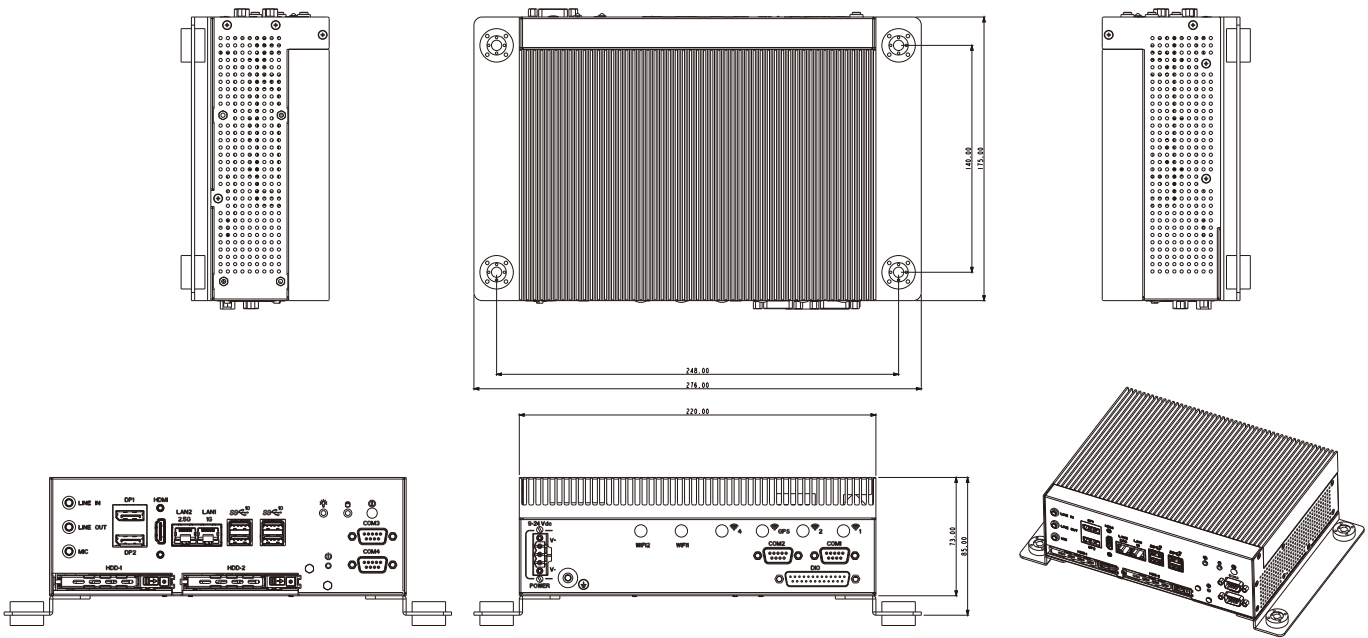

I/O Connectors



Packing List

- 1 x AIV-TGH7B-system x 1
- 2 x Wall mount bracket
- 1 x 3-Pin Terminal block
- 1 x Screws Package

Order Information

AIV-TGH7B1	AIV-TGH7B1, Intel i7-11850HE, 9-24Vdc
AIV-TGH7B2	AIV-TGH7B2, Intel i5-11500HE, 9-24Vdc
AIV-TGH7B3	AIV-TGH7B3, Intel i3-11100HE, 9-24Vdc

Optional Accessory

DDR4 32G	Certified DDR4 32GB 3200MHz RAM
DDR4 16G	Certified DDR4 16GB 3200MHz RAM
DDR4 8G	Certified DDR4 8GB 3200MHz RAM
DDR4 4G	Certified DDR4 4GB 3200MHz RAM
5G Module	5G & GNSS Module with Dual Antenna
4G Module	4G & GNSS Module with Dual Antenna
WiFi & Bluetooth Module	WiFi & Bluetooth Module with Dual Antenna

AIV-TGH7E

11th Gen Intel® Core™ i7/i5/i3 Processor(Tiger Lake)
Fanless In-Vehicle Computer



Features

- Intel® 11th Generation Core™ i7/i5/i3 Processor
- Support 1 DDR4 3200 SODIMM, up to 32GB
- Support 2.5GbE, USB 3.2 Gen2
- CAN Bus provide
- Two front easy access 2.5" SATA III storage bay
- 9-32Vdc w/in-vehicle power ignition control
- Fanless design
- Wide Operating Temperature -40~65°C

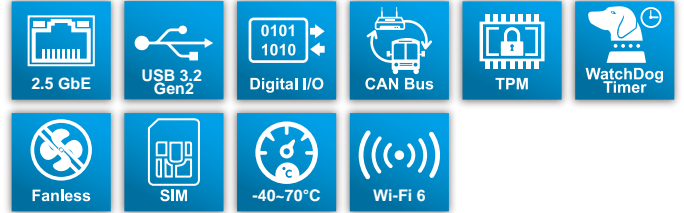

CE FC

Others

TPM	Optional By Request
Watchdog Timer	255 Levels
Smart Management	Wake on LAN, PXE supported
HW Monitor	Monitoring temperature, voltages. Auto throttling control when CPU overheats.

Software

OS Support	Windows 10, Linux
------------	-------------------

Power Requirement

Power Input	9V to 32V, DC-in
Power Interface	3-pin Terminal Block : V+, IGN, V- With Power Ignition Control

Mechanical & Environment

Dimension	220mm(W) x 175mm(D) x 73mm(H) (8.66" x 6.89" x 2.87")
Weight	TBD
Mounting	Wallmount
Operating Temperature	-40°C to 65°C (-40°F to 149°F)
Storage Temp	-40°C to 80°C (-40°F to 176°F)
Humidity	5% to 90% Humidity, non-condensing
Shock	IEC 60068-2-27 SSD : 50G @ wallmount, Half-sine, 11ms
Vibration	IEC 60068-2-64 SSD : 5Grms, 5Hz to 500Hz, 3 Axis
EMC	CE / FCC class A/ E-Mark

*Please adopt wide operation temperature RAM, SSD, HDD to get better and stable system performance.

Specification

System

CPU	Intel® 11th Generation Core™ i7/i5/i3 Processor (Tiger Lake-H) i7-11850HE (8C/16T, 2.60GHz, up to 4.70GHz) i5-11500HE (6C/12T, 2.60GHz, up to 4.50GHz) i3-11100HE (4C/8T, 2.40GHz, up to 4.40GHz)
Chipset	Intel® HM570E
Memory	1 DDR4-3200 Memory supports up to 32GB (ECC)

Video

Graphic Controller	Intel® Iris® X Graphics
Interface	1 HDMI , 2 DP

Storage

SATA	2 SATA III (6Gbps) support S/W RAID 0, 1
Storage Device	2 Front-access 2.5" SSD/HDD Tray

I/O

LAN	LAN 1 : RJ45 Type Intel® I225 2.5GigE LAN LAN 2 : RJ45 Type Intel® I219 GigE LAN
Serial	2 DB9 Type RS-232/RS422/485 2 DB9 Type RS-232
USB	4 Type A USB 3.2 Gen2
DIO	16 DIO, DB25 Type connector
Audio	1 Mic-in, 1 Line-in, 1 Line-out
CAN BUS	1 DB9 CANBus
LED	Power, HDD, Status
Button	1 Power Press Button
Antenna Hole	6 Antenna Holes

Expansion

Mini PCIe	1 x Half Size Mini PCIe slot
M.2	1 x M.2 B Key(3052)
SIM Slot	1 Nano SIM Slot (Internal)

Dimension

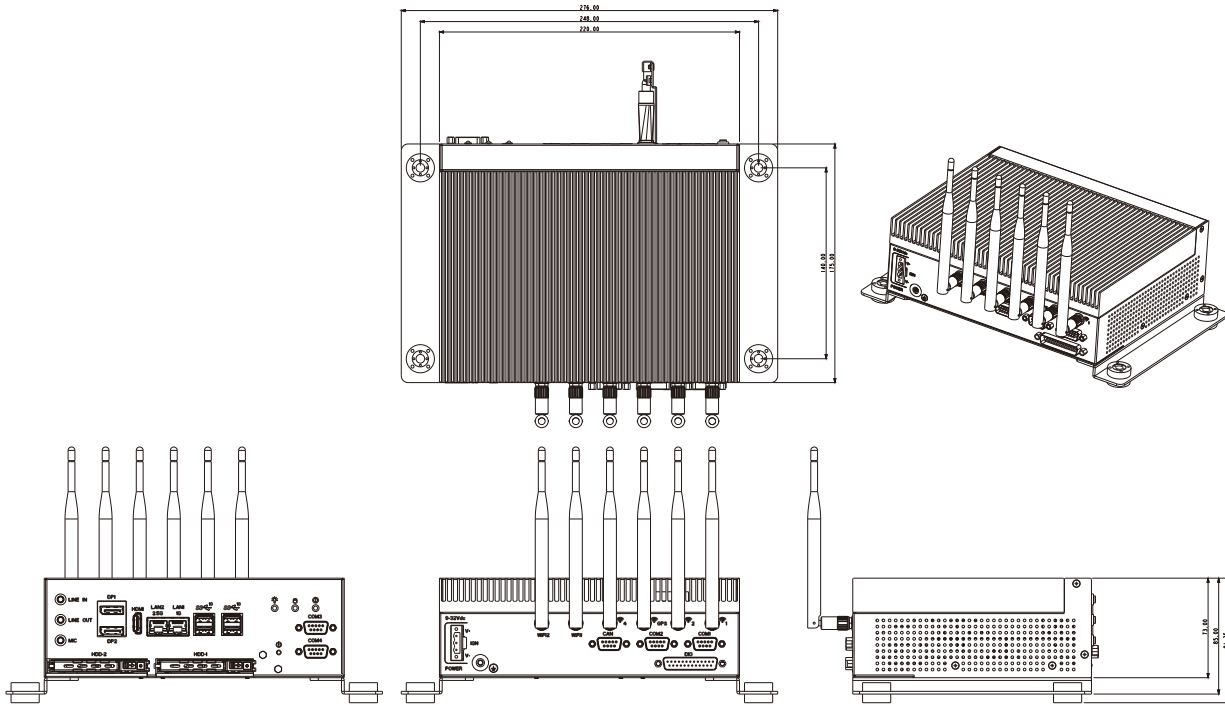

I/O Connectors



Packing List

- 1 x AIV-TGH7E-Series
- 2 x Wall mount bracket
- 1 x 3-Pin Terminal block
- 1 x Screws Package

Order Information

AIV-TGH7E7-A10	AIV-TGH7EX, Intel i7-11850HE, CANBus
AIV-TGH7E5-A10	AIV-TGH7EX, Intel i5-11500HE, CANBus
AIV-TGH7E3-A10	AIV-TGH7EX, Intel i3-11100HE, CANBus

Optional Accessory

DDR4 32G	Certified DDR4 32GB 3200MHz RAM
DDR4 16G	Certified DDR4 16GB 3200MHz RAM
DDR4 8G	Certified DDR4 8GB 3200MHz RAM
DDR4 4G	Certified DDR4 4GB 3200MHz RAM
5G Module	5G & GNSS Module with 2 Antennas, 1 GPS antenna
4G Module	4G & GNSS Module with 3 Antennas, 1 GPS antenna
WiFi & Bluetooth Module	WiFi & Bluetooth Module with Dual Antenna

AIV-Q170V1FL

Intel® 6th-Gen Core™ i7/i5/i3 Skylake in-vehicle fanless embedded computer



Features

- Intel® 6th Generation Core™ Desktop Processor
- Support 4 X POE GbE LAN port with RJ45 connector
- Support 2 x swappable 2.5 inch SSD bay
- Support 3 x Mini PCI-e
- In-vehicle power design : 9-36Vdc power input with power ignition



Specification

System

CPU	Intel® Sky-lake-S 6th Gen Core™ i7-6700 TE Intel® Sky-lake-S 6th Gen Core™ i5-6500 TE Intel® Sky-lake-S 6th Gen Core™ i3-6100 TE
Chipset	Intel® Q170 chipset
Memory	2 x DDR4-SO-DIMM

Video

Chipset	Intel® HD Graphics 530
Video Memory	Integrated
Video Interface	1 x HDMI (With locking bracket) 1 x VGA 1 x DVI-D

Storage

SATA	2 x SATA III port
Disk Bay	2 x swappable 2.5 inch SSD bay
CF	1 x CFast

I/O

Ethernet	2 x GbE, RJ45, Intel i210IT chipset
PoE	4 X POE GbE LAN port with RJ45 connector (802.3at ,total 60W max)
USB	8 X USB 3.0
Serial Port	4 X COM - DB9 (RS232/RS422/485)
CAN Bus	CAN Bus 2.0B or OBD II (J1939) by SKU
GPIO	GPIO 4-in / 4-out,
Audio	3 x Audio jack Green: Audio out Blue: Remote switch Pink : Mic in
Mini-PCI-e	3 x Mini PCI-e socket
SIM Card	2 x SIM card Socket

Others

WatchDog Timer	1~255 sec. software programmable(0=Disable)
TPM	On-board TPM 2.0 (By request)
G Sensor	1 x G Sensor board

Software

OS Support	Windows 10 (64 bit) / Linux kernel to 4.4 or above(64 bit)
------------	--

Power Requirement

Power Input	Power sub system spec:9-36Vdc Power Input with power ignition function
-------------	--

Mechanical & Environment

Dimension	270mm x 170 mm x 63 mm
Operating Temp.	-25 ~ 60°C
Chassis	Aluminum extrusion heat sink & metal chassis
Thermal Design	Fan less
Weight	6.2 Kg
Storage Temp	-40~80°C (-40~176°F)
Safety	CE / FCC class B / E Mark ,

Dimension

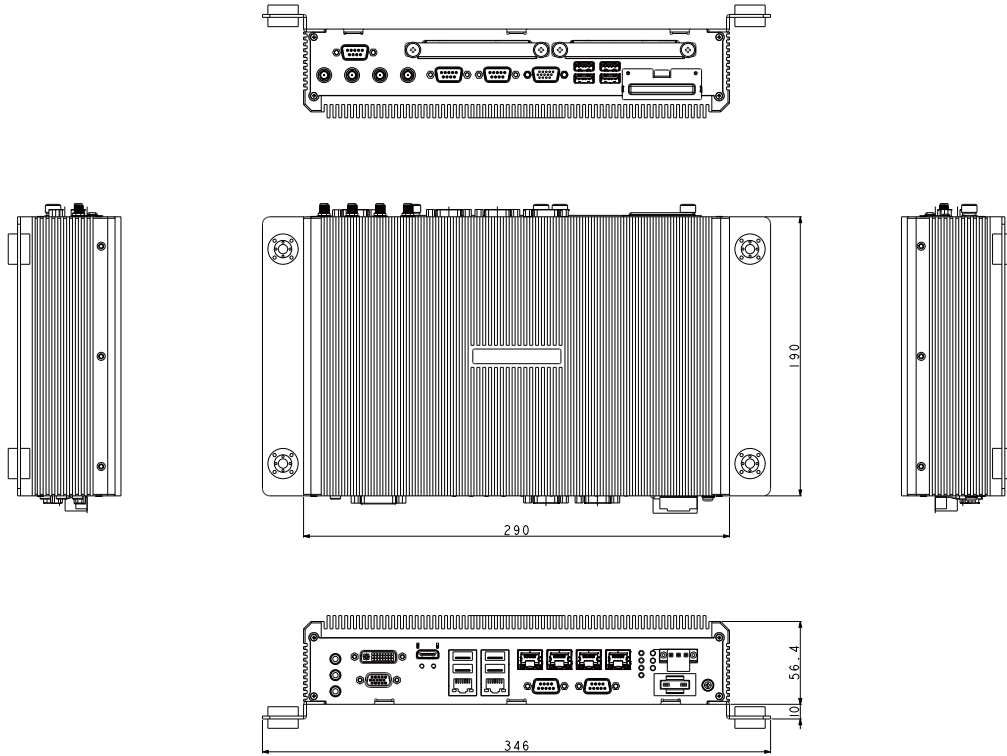

I/O Connectors

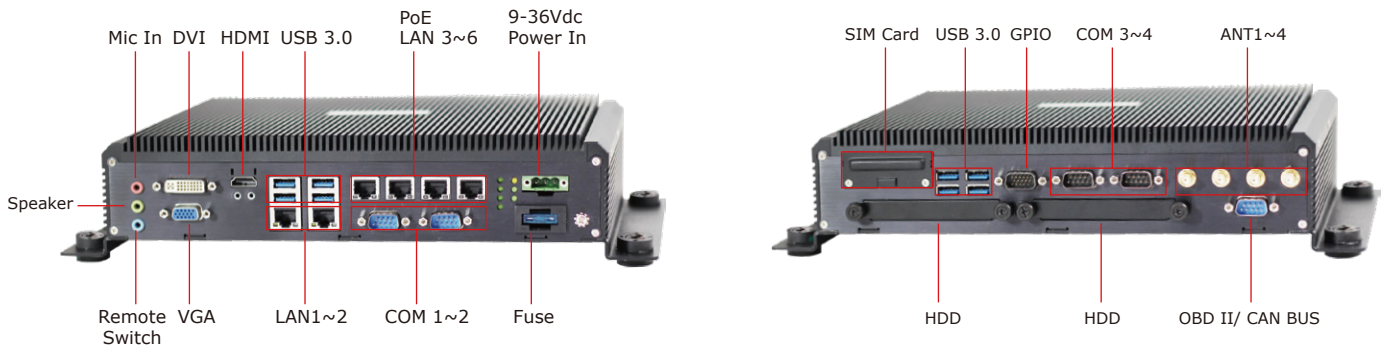

Packing List

- 1 x AIV-Q170V1FL
- 1 x System Driver CD
- 1 x Terminal block female 3pin
- 1 x HDMI locking bracket
- 1 x 8 bit GPIO/CAN Cable
- 1 x Remote switch cable

Ordering Information

AIV-Q170V1FL	AIV-Q170V1FL (with CAN Bus)
AIV-Q170V1FL-OBDD	AIV-Q170V1FL-OBDD (with OBD II)
AIV-Q170V1FLS	AIV-Q170V1FLS (with CAN Bus , S SKU for install Sierra wireless module use)
AIV-Q170V1FLS-OBDD	AAIV-Q170V1FLS-OBDD (with OBD II, S SKU for install Sierra wireless module use)

Optional Module List

- EC20/EC25 (Quectel)(4G + GPS + Glonass)module
- Sierra MC7430(APAC)(4G + GPS + Glonass)for s moodel only
- Sierra MC7455(America)(4G + GPS + Glonass)for s moodel only
- Jwx6058 (Qualcomm. QCA6174A-5)Wi-Fi5+BT5.0
- G sensor Board (ADXL345)
- 4GB DDR4 2133 SO-DIMM 1Rx8
- 8GB DDR4 2133 SO-DIMM 2Rx8

AIV-APL1V1FL

New Intel Pentium-N4200 Fan Less In-Vehicle Computer



Features

- Rugged fan-less design
- Support New Intel Pentium N4200 processors
- 1 x DDR3L 1866 MHz SO-DIMM, up to 8GB
- Support CAN 2.0A/2.0B or ODB II (By SKU)
- VGA & DVI video output
- 2 x swappable 2.5" HDD bay
- Variety Wireless Communication
- Support 9-36Vdc with power ignition

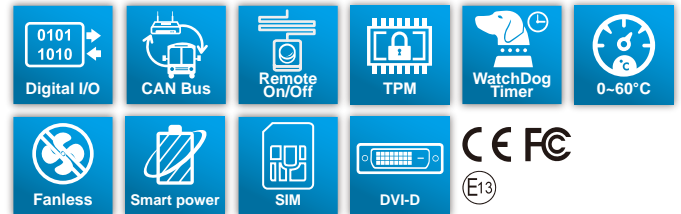

Others Feature

WatchDog Timer 1~255 sec. software programmable

Software

OS Support Windows 10 (64 bit)& Linux kernel to 4.4 or above(64 bit)

Power Requirement

Power Input 9-36Vdc with power ignition

Mechanical & Environment

Dimension 260mm x 195mm x 63mm
 Operating Temp. -25°C ~ 60°C
 Vibration IEC 60068-2-64, 5~500Hz, 3GRMS(SSD)
 Shock IEC 60068-2-27, 50G 500m/s² 11MS
 Storage Temp -40~80°C (-40~176°F)
 Safety CE, FCC class B, E-Mark

Smart In-Vehicle Power Management

O/S Anti-Crash Smart O/S boot/shut-down control by power subsystem
 System boot / Shut-down delay Delay time from 0 seconds to 60 minutes setting in BIOS
 System boot fail retry 3 times boot fail retry
 Power on/off switches

- System power switch by remote cable switch
- System power input serial connection to car battery and ignition switch

 Car battery protection Low battery voltage monitoring and configurable auto shutdown low battery voltage level

Specification

System

CPU	Intel® Pentium™-N4200
Chipset	Intel Apollo lake SoC
Memory	2 x DDR3L 1866 MHz ,SO-DIMM, support up to 8GB

Video

Graphic Controller	Intel HD Graphics 505
Video Interface	1 x VGA port (DB15) ,1 x DVI

Storage

SATA	2 x SATA III port
Disk Bay	2 x swappable 2.5" Disk bay with Anti-vibration/ Anti-shock solution for SSD only

I/O

Expansion Slot	3 x Mini PCI-e(Reserve for Wi-Fi and 4G LTE)
Ethernet	2 x GbE RJ45, Intel i210AT
Serial Port	1 x RS-232/422/485 3 x RS-232
USB	4 X USB 3.0
GPIO	8-bit GPIO (4 In, 4 Out)
Audio	1 x MIC in 1 x Audio out
Antenna Hole	1 x SMA for GPS 1 x SMA for 4G 2 x SMA for Wi-Fi & Bluetooth
SIM	SIM Slot x 2, SIM card changeable without opening case, latch to protect SIM uncertainly touch
CAN BUS	DB9 connector, support CAN 2.0A/2.0B protocol (J1939 for optional)
TPM	On-board TPM 1.2 / 2.0(By Request)

Dimension

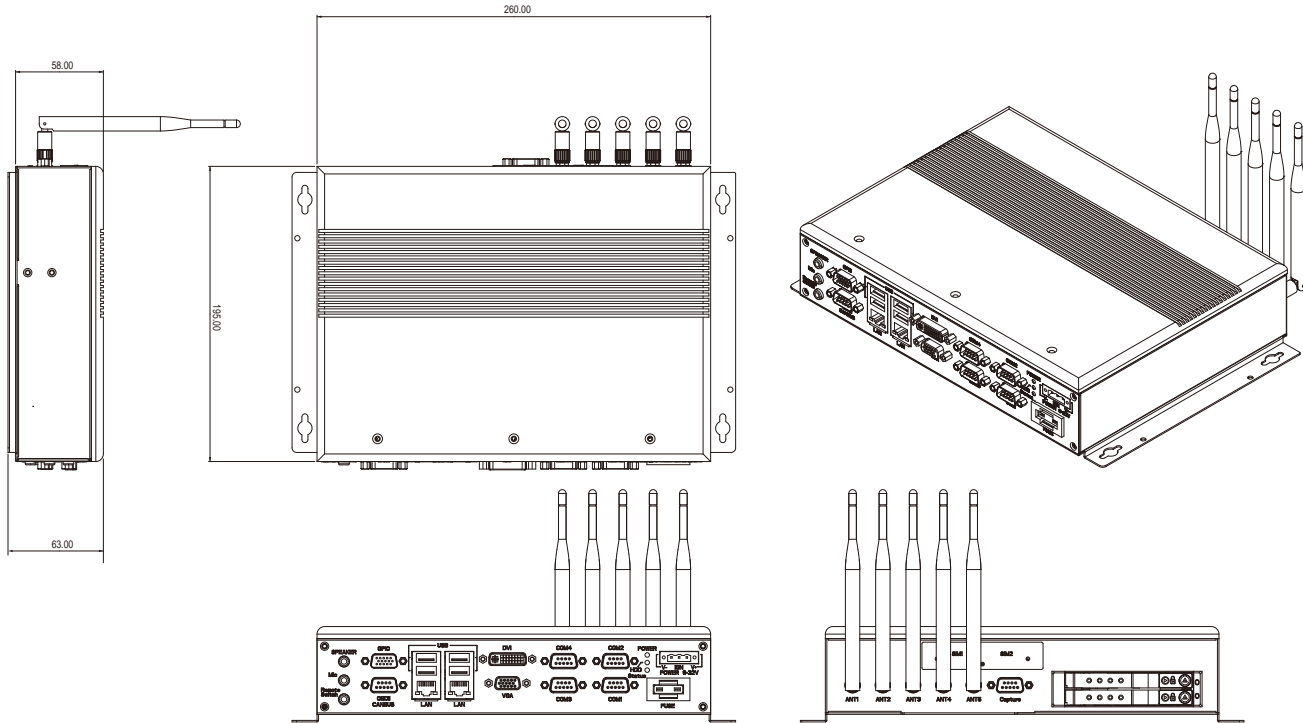

I/O Connectors



Packing List

- 1 x AIV-APL1V1FL
- 1 x User Guide CD with driver
- 1 x GPIO/CAN Cable
- 1 x Terminal block (Plug-DC connector)
- 1 x Remote Switch Cable
- 1 x Antenna for GPS (option)
- 2 x Antenna for Wi-Fi & Bluetooth (option)
- 1 x Antenna for 4G LTE (option)
- 1 x Spare Fuse

Ordering Information

AIV-APL1V1FL-PT1 AIV-APL1V1FL- Intel Pentium N4200+CAN 2.0
 AIV-APL1V1FL-PT1OB AIV-APL1V1FL- Intel Pentium N4200+OBD II

Optional Modules

EC20/EC25	Quectel 4G + GPS + Glonass module
MC7455/MC7430	Sierra 4G + GPS + Glonass module
Jwx6058	Qualcomm. (QCA6174A-5) Wi-Fi5+BT5.0
SC330N4	Yuan Analog Capture card 4ch With Testing Cable
G-SenSor	G-SenSor board

Autonomous Driving Controller

Autonomous Driving Controller, Automated driving systems, vehicle servers, autonomous computers, are so complicated and miscellaneous, the automated driving system integrators need partners with years of experience in network appliances and in-vehicle computers.

Acrosser Technology, founded in 1987, is a pioneer in the evolution of industrial computing. For several decades, Acrosser has provided innovative network appliances and in-vehicle computer solutions to thousands of customers, helping them reduce the time-to-market and gaining higher competence to win the market.

Autonomous Vehicles Application

Acrosser Autonomous Vehicles Plays Significant Role in Telematics



Server/workstation
Performance



CAN Bus



POE



Wide temp



Delay Time
on/off



ANTI
VIBRATION



Power
Management



Wireless



AAD-W480B

10th Gen Intel® Core™ Xeon/i9/i7 Processor
Autonomous Driving Controller

3 x PCIe Slot

Product Matrix

Autonomous Driving Controller



Form Factor	Autonomous Driving Controller	
Model Name	AAD-W480A	AAD-W480A1-P, AAD-W480A2-P
Specification		
CPU	Intel®10th Gen Core™ Xeon/i9/i7 Processor	Intel®10th Gen Core™ Xeon/i9/i7 Processor
Chipset	Intel® W480E	Intel® W480E
Memory	2 x 260 PIN DDR4-3200 SODIMM supports up to 64GB (Up to 32GB per socket)	2 x 260 PIN DDR4-3200 SODIMM supports up to 64GB (Up to 32GB per socket)
Video		
Video Interface	1 VGA, 1 DVI-D, 1 HDMI1.4b	1 VGA, 1 DVI-D, 1 HDMI1.4b
Storage		
SATA	2 x SATA III (6Gbps) support S/W RAID 0, 1	2 x SATA III (6Gbps) support S/W RAID 0, 1
M.2	1 M.2 Key M Socket (2280) NVMe SSD (Internal)	1 M.2 Key M Socket (2280) NVMe SSD (Internal)
Storage Device	2 Front-access 2.5" SSD/HDD Tray	2 Front-access 2.5" SSD/HDD Tray
I/O		
Expansion Slot	2 x Full Size Mini PCIe Slots 1 x M.2 B Key(3042) 1 SIM Slot (Internal) 1 PCIe[x16] Slot, 1 PCIe[x4] Slot	2 x Full Size Mini PCIe Slots 1 x M.2 B Key(3042) 1 SIM Slot (Internal) 1 PCIe[x16] Slot, 1 PCIe[x4] Slot
LAN	LAN 1 : RJ45 Type Intel® I210IT GigE LAN LAN 2 : RJ45 Type Intel® I210IT GigE LAN	LAN 1 : RJ45 Type Intel® I210IT GigE LAN LAN 2 : RJ45 Type Intel® I210IT GigE LAN
Serial	4 DB9 Type RS-232/RS422/485	4 DB9 Type RS-232/RS422/485
USB	6 Type A USB 3.2 Gen2	6 Type A USB 3.2 Gen2
DIO	4DI,4DO, DB15 Type connector	4DI,4DO, DB15 Type connector
Audio	1 Mic-in, 1 Line-out	1 Mic-in, 1 Line-out
CAN BUS	1 DB9 CANBus	1 DB9 CANBus
PoE	-	2 RJ45 Type PoE ports, Complies with IEEE 802.3af, up to 15.4W at 48V per PoE port-Complies with EN61000-4-2 (ESD) Air-15kV, Contact-8kV
LED	Power, HDD, Status	Power, HDD, Status
Button	1 Power Press Button	1 Power Press Button
Antenna Hole	7 Antenna Holes	7 Antenna Holes
Power Requirement		
Power Input	9V to 55V, DC-in	9V to 55V, DC-in
Software		
OS Support	Windows 10, Linux	Windows 10, Linux
Mechanical & Environment		
Dimension	TBDTBD	TBDTBD
Operating Temp	35W TDP CPU : -30°C to 60°C 65W TDP CPU : -30°C to 50°C 80W TDP CPU : -30°C to 40°C with system fan When Install Graphics Card: -20°C to 45°C with system fan	35W TDP CPU : -30°C to 60°C 65W TDP CPU : -30°C to 50°C 80W TDP CPU : -30°C to 40°C with system fan When Install Graphics Card: -20°C to 45°C with system fan
Vibration/Shock/Safety	CE / FCC class A/ E-Mark IEC 60068-2-27, SSD : 50G @ wallmount, Half-sine, 11ms IEC 60068-2-64, SSD : 5Grms, 5Hz to 500Hz, 3 Axis	
Optional Wireless Module		
4G/5G	4G/5G & GNSS Module with Dual Antenna	
WiFi / Bluetooth	WiFi & Bluetooth Module with Dual Antenna	
Reference		
Page	18	20

Product Matrix

Autonomous Driving Controller



Form Factor	Autonomous Driving Controller	
Model Name	AAD-W480B	AAD-W480B1-P, AAD-W480B2-P
Specification		
CPU	Intel®10th Gen Core™ Xeon/i9/i7 Processor	Intel®10th Gen Core™ Xeon/i9/i7 Processor
Chipset	Intel® W480E	Intel® W480E
Memory	2 x 260 PIN DDR4-3200 SODIMM supports up to 64GB (Up to 32GB per socket)	2 x 260 PIN DDR4-3200 SODIMM supports up to 64GB (Up to 32GB per socket)
Video		
Video Interface	1 VGA, 1 DVI-D, 1 HDMI1.4b	1 VGA, 1 DVI-D, 1 HDMI1.4b
Storage		
SATA	2 x SATA III (6Gbps) support S/W RAID 0, 1	2 x SATA III (6Gbps) support S/W RAID 0, 1
M.2	1 M.2 Key M Socket (2280) NVMe SSD (Internal)	1 M.2 Key M Socket (2280) NVMe SSD (Internal)
Storage Device	2 Front-access 2.5" SSD/HDD Tray	2 Front-access 2.5" SSD/HDD Tray
I/O		
Expansion Slot	2 x Full Size Mini PCIe Slots 1 x M.2 B Key(3042) 1 SIM Slot (Internal) 2 PCIe[x16] Slot with PCIe x8 signal , 1 PCIe[x4] Slot	2 x Full Size Mini PCIe Slots 1 x M.2 B Key(3042) 1 SIM Slot (Internal) 2 PCIe[x16] Slot with PCIe x8 signal , 1 PCIe[x4] Slot
LAN	LAN 1 : RJ45 Type Intel® I210IT GigE LAN LAN 2 : RJ45 Type Intel® I210IT GigE LAN	LAN 1 : RJ45 Type Intel® I210IT GigE LAN LAN 2 : RJ45 Type Intel® I210IT GigE LAN
Serial	4 DB9 Type RS-232/RS422/485	4 DB9 Type RS-232/RS422/485
USB	6 Type A USB 3.2 Gen2	6 Type A USB 3.2 Gen2
DIO	4DI,4DO, DB15 Type connector	4DI,4DO, DB15 Type connector
Audio	1 Mic-in, 1 Line-out	1 Mic-in, 1 Line-out
CAN BUS	1 DB9 CANBus	1 DB9 CANBus
PoE	-	2 RJ45 Type PoE ports, Complies with IEEE 802.3af, up to 15.4W at 48V per PoE port-Complies with EN61000-4-2 (ESD) Air-15kV, Contact-8kV
LED	Power, HDD, Status	Power, HDD, Status
Button	1 Power Press Button	1 Power Press Button
Antenna Hole	7 Antenna Holes	7 Antenna Holes
Power Requirement		
Power Input	9V to 55V, DC-in	9V to 55V, DC-in
Software		
OS Support	Windows 10, Linux	Windows 10, Linux
Mechanical & Environment		
Dimension	TBD	TBD
Operating Temp	35W TDP CPU : -30°C to 70°C 65W TDP CPU : -30°C to 50°C 80W TDP CPU : -30°C to 40°C with system fan When Install Graphics Card: -20°C to 45°C with system fan	35W TDP CPU : -30°C to 70°C 65W TDP CPU : -30°C to 50°C 80W TDP CPU : -30°C to 40°C with system fan When Install Graphics Card: -20°C to 45°C with system fan
Vibration/Shock/Safety	CE / FCC class A/ E-Mark IEC 60068-2-27, SSD : 50G @ wallmount, Half-sine, 11ms IEC 60068-2-64, SSD : 5Grms, 5Hz to 500Hz, 3 Axis	
Optional Wireless Module		
4G/5G	4G/5G & GNSS Module with Dual Antenna	
WiFi / Bluetooth	WiFi & Bluetooth Module with Dual Antenna	
Reference		
Page	22	24

Product Matrix

Autonomous Driving Controller



Form Factor	Autonomous Driving Controller
Model Name	AAD-C622A
Specification	
CPU	Intel®2nd Gen Xeon Scalable processor
Memory	6 x DDR4-2933 RDIMM (up to 384GB)
Video	
Video Interface	1 x VGA (By optional accessory kit)
Storage	
SATA	2 x SATA III (6Gbps) support S/W RAID 0, 1
Disk Bay	2 x NVME swappable SSD bay
I/O	
Expansion Slot	5 PCIe slots: - 3 x PCIe x16 Gen3 slot (x8 signal) - 2 x PCIe x16 Gen3 slot (x4 signal)
Ethernet	6 x M12 X-coded I210-IT GbE LAN, 2 x M12 X-coded X550-AT2 10GbE LAN (By optional accessory kit)
Serial Port	2 x RS232/RS422/485
USB	8 x Anti-loosening USB3.2
GPIO	4 In, 4 Out
Audio	<ul style="list-style-type: none"> ● Green: Audio out ● Blue: Use for Remote on/off switch ● Pink : Mic in
SIM	2 x SIM card Socket
Can Bus (2.0A/2.0B)	YES
Power Requirement	
Power Input	DC 12 V 1000W / DC 24/48 V 1200W
Software	
OS Support	Ubuntu 18.04LTS.
Mechanical & Environment	
Dimension	AAD-C622A1 : 359 (W) x 280 (H) x 510 (D) mm AAD-C622A2 : 359 (W) x 200 (H) x 510 (D) mm
Operating Temp	-20 ~ 60°C with GPU cards
Vibration/Shock/Safety	CE / FCC class B / E Mark / cULus / RoHS IEC 60068-2-64, 5~500Hz, 3GRMS(CF/SSD) IEC 60068-2-27, 50G 500m/s ² 11MS
Optional Wireless Module	
4G	GPRS/EDGE/WCDMA/HSUPA/HSDPA
GPS / WiFi / Bluetooth	YES, IEEE 802.11 b/g/n, YES
Reference	
Page	26

AAD-W480A

10th Gen Intel® Core™ Xeon/i9/i7 Processor (Comet Lake)
AI@Edge Autonomous in-vehicle Server Computer With
2PCIe, Support One Graphic Card



Features

- Workstation-grade Platform : 10-core 10th Gen Intel® Xeon®/Core™ i9/i7/i5/i3 Processor (CML-S) running with Intel® W480E chipset supports max 80W TDP CPU
- Support 2 DDR4 3200 SODIMM, up to 64GB (Non-ECC)
- Support 2 GigaLAN, 6 USB 3.2 Gen2
- Support 1 PCIe x16, 1 PCIe x4 expansion slots
- Could Sports one NVIDIA RTX 30 series graphics cards (Max.320W)
- CAN Bus Provide
- Two Front Easy Access 2.5" SATA III Storage Bay
- 9-55Vdc Power Input w/in-vehicle Power Ignition Control, up to 500W Power Input



Others

TPM	Optional By Request
Watchdog Timer	255 Levels
Smart Management	Wake on LAN, PXE supported
HW Monitor	Monitoring temperature, voltages. Auto throttling control when CPU overheats.

Software

OS Support	Windows 10, Linux
------------	-------------------

Power Requirement

Power Input	9V to 55V, DC-in
Power Interface	3-pin Terminal Block : V+, IGN, V- With Power Ignition Control

Mechanical & Environment

Dimension	TBD
Weight	TBD
Mounting	Wallmount
Operating Temperature	35W TDP CPU : -30°C to 60°C 65W TDP CPU : -30°C to 50°C 80W TDP CPU : -30°C to 40°C with system fan When Install Graphics Card: -20°C to 45°C with system fan
Storage Temp	-40°C to 85°C (-40°F to 185°F)
Humidity	5% to 90% Humidity, non-condensing
Shock	IEC 60068-2-27 SSD : 50G @ wallmount, Half-sine, 11ms
Vibration	IEC 60068-2-64 SSD : 5Grms, 5Hz to 500Hz, 3 Axis
EMC	CE / FCC class A/ E-Mark

*Please adopt wide operation temperature RAM, SSD, HDD to get better and stable system performance.

*If customer want to install CPU TDP up to 80W or high level GPU card, we will suggest to choose system sku with system fan version to get better thermal solution and system performance.

Specification

System

CPU	Intel® 10th Gen. Xeon®/Core™ i9/i7 Processor, support max 80W TDP CPU, socket type, LGA1200
Chipset	Intel® W480E
Memory	2 x 260 PIN DDR4-3200 SODIMM supports up to 64GB (Up to 32GB per socket)

Video

Graphic Controller	Intel® UHD Graphics 630
Interface	1 VGA, 1 DVI-D, 1 HDMI1.4b

Storage

SATA	2 SATA III (6Gbps) support S/W RAID 0, 1
M.2	1 M.2 Key M Socket (2280) NVMe SSD (Internal)
Storage Device	2 Front-access 2.5" SSD/HDD Tray

I/O

LAN	LAN 1 : RJ45 Type Intel® I210IT GigE LAN LAN 2 : RJ45 Type Intel® I210IT GigE LAN
Serial	4 DB9 Type RS-232/RS422/485
USB	6 Type A USB 3.2 Gen2
DIO	4DI,4DO, DB15 Type connector
Audio	1 Mic-in, 1 Line-out
CAN BUS	1 DB9 CANBus
LED	Power, HDD, Status
Button	1 Power Press Button
Antenna Hole	7 Antenna Holes

Expansion

Mini PCIe	2 x Full Size Mini PCIe Slots
M.2	1 x M.2 B Key(3042)
SIM Slot	1 SIM Slot (Internal)
PCIe Slot	1 PCIe[x16] Slot, 1 PCIe[x4] Slot

Dimensions

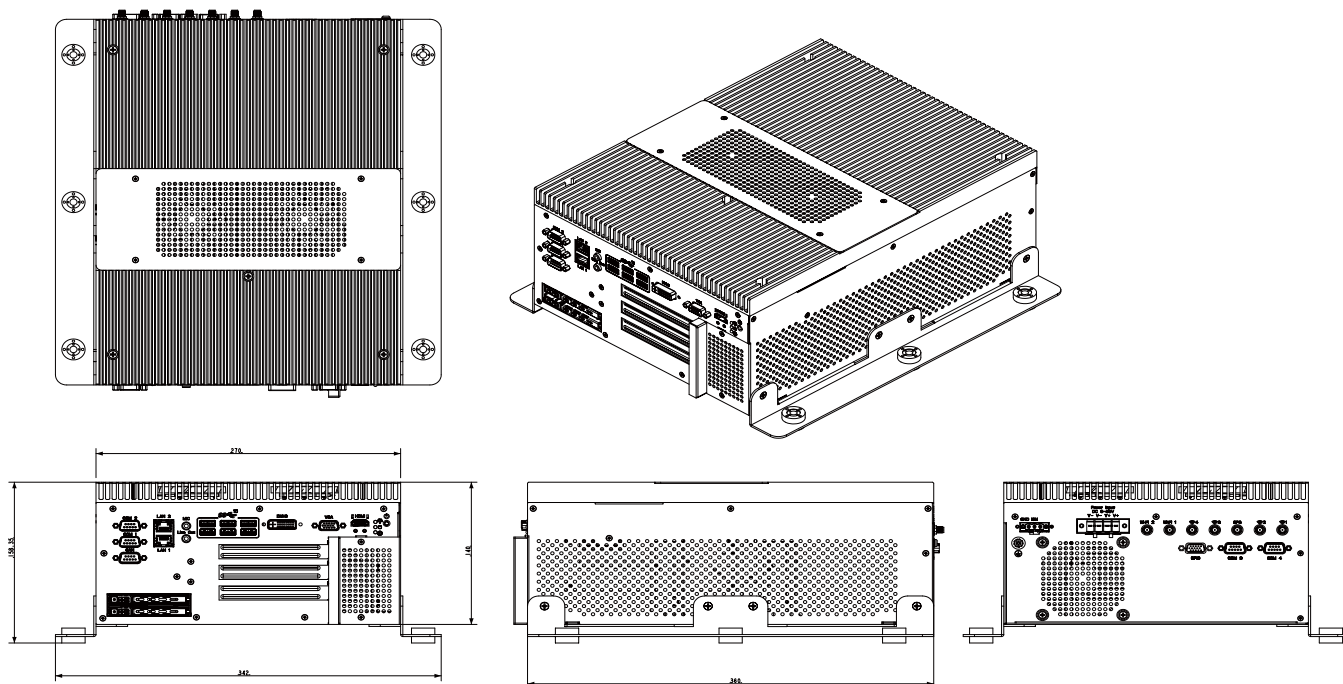

I/O Connectors

Packing List

- 1 x AAD-W480A
- 2 x Wall mount bracket
- 1 x Terminal block
- 1 x Screws Package
- 1 x GPU fixing kit

CPU List

Series	CPU	GHz	TDP (W)	ECC RAM
Intel® Xeon®	W-1290TE	4.5	35	Yes
	W-1270E	4.8	80	
	W-1270TE	4.4	35	
	W-1250E	4.7	80	
	W-1250TE	3.8	35	
Intel® Core™	i9-10900E	4.7	65	NA
	i9-10900TE	4.5	35	
	i7-10700E	4.5	65	
	i7-10700TE	4.4	35	

Order Information

AAD-W480A1-000	AAD-W480A1, Socket Type CPU Platform, 2 PCIe, CANBus
AAD-W480A2-000	AAD-W480A2, Socket Type CPU Platform, 2 PCIe, CANBus, With System Fan

Optional Accessory

DDR4 32G	Certified DDR4 32GB 3200MHz RAM(Non-ECC)
DDR4 16G	Certified DDR4 16GB 3200MHz RAM(Non-ECC)
DDR4 8G	Certified DDR4 8GB 3200MHz RAM(Non-ECC)
DDR4 4G	Certified DDR4 4GB 3200MHz RAM(Non-ECC)
5G Module	5G & GNSS Module with Dual Antenna
4G Module	4G & GNSS Module with Dual Antenna
WiFi & Bluetooth Module	WiFi & Bluetooth Module with Dual Antenna

AAAD-W480A1/2-P

10th Gen Intel® Core™ Xeon/i9/i7 Processor (Comet Lake) AI @Edge Autonomous in-vehicle Server Computer With 2PCIe, Support One Graphic Card, Dual PoE For Surveillance



Specification

System

CPU	Intel® 10th Gen. Xeon®/Core™ i9/i7 Processor, support max 80W TDP CPU, socket type, LGA1200
Chipset	Intel® W480E
Memory	2 x 260 PIN DDR4-3200 SODIMM supports up to 64GB (Up to 32GB per socket)

Video

Graphic Controller	Intel® UHD Graphics 630
Interface	1 VGA, 1 DVI-D, 1 HDMI1.4b

Storage

SATA	2 SATA III (6Gbps) support S/W RAID 0, 1
M.2	1 M.2 Key M Socket (2280) NVMe SSD (Internal)
Storage Device	2 Front-access 2.5" SSD/HDD Tray

I/O

LAN	LAN 1 : RJ45 Type Intel® I210IT GigE LAN LAN 2 : RJ45 Type Intel® I210IT GigE LAN
Serial	4 DB9 Type RS-232/RS422/485
USB	6 Type A USB 3.2 Gen2
DIO	4DI,4DO, DB15 Type connector
Audio	1 Mic-in, 1 Line-out
CAN BUS	1 DB9 CANBus
PoE	2 RJ45 Type PoE ports, Complies with IEEE 802.3af, up to 15.4W at 48V per PoE port-Complies with EN61000-4-2 (ESD) Air-15kV, Contact-8kV
LED	Power, HDD, Status
Button	1 Power Press Button
Antenna Hole	7 Antenna Holes

Expansion

Mini PCIe	2 x Full Size Mini PCIe Slots
M.2	1 x M.2 B Key(3042)
SIM Slot	1 SIM Slot (Internal)
PCIe Slot	1 PCIe[x16] Slot, 1 PCIe[x4] Slot

Features

- Workstation-grade Platform : 10-core 10th Gen Intel® Xeon®/Core™ i9/i7/i5/i3 Processor (CML-S) running with Intel® W480E chipset supports max 80W TDP CPU
- Support 2 DDR4 3200 SODIMM, up to 64GB (Non-ECC)
- Support 2 GigaLAN, 6 USB 3.2 Gen2
- Support 1 PCIe x16, 1 PCIe x4 expansion slots
- Could Sports one NVIDIA RTX 30 series graphics cards (Max.320W)
- CAN Bus Provide
- Two Front Easy Access 2.5" SATA III Storage Bay
- 9-55Vdc Power Input w/in-vehicle Power Ignition Control, up to 500W Power Input

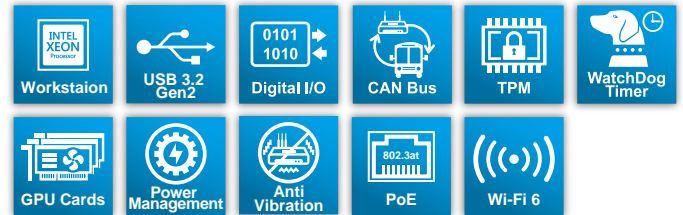

Others

TPM	Optional By Request
Watchdog Timer	255 Levels
Smart Management	Wake on LAN, PXE supported
HW Monitor	Monitoring temperature, voltages. Auto throttling control when CPU overheats.

Software

OS Support	Windows 10, Linux
------------	-------------------

Power Requirement

Power Input	9V to 55V, DC-in
Power Interface	3-pin Terminal Block : V+, IGN, V- With Power Ignition Control

Mechanical & Environment

Dimension	TBD
Weight	TBD
Mounting	Wallmount
Operating Temperature	35W TDP CPU : -30°C to 60°C 65W TDP CPU : -30°C to 50°C 80W TDP CPU : -30°C to 40°C with system fan When Install Graphics Card: -20°C to 45°C with system fan
Storage Temp	-40°C to 85°C (-40°F to 185°F)
Humidity	5% to 90% Humidity, non-condensing
Shock	IEC 60068-2-27 SSD : 50G @ wallmount, Half-sine, 11ms
Vibration	IEC 60068-2-64 SSD : 5Grms, 5Hz to 500Hz, 3 Axis
EMC	CE / FCC class A/ E-Mark

*Please adopt wide operation temperature RAM, SSD, HDD to get better and stable system performance.

*If customer want to install CPU TDP up to 80W or high level GPU card, we will suggest to choose system sku with system fan version to get better thermal solution and system performance.

Dimensions

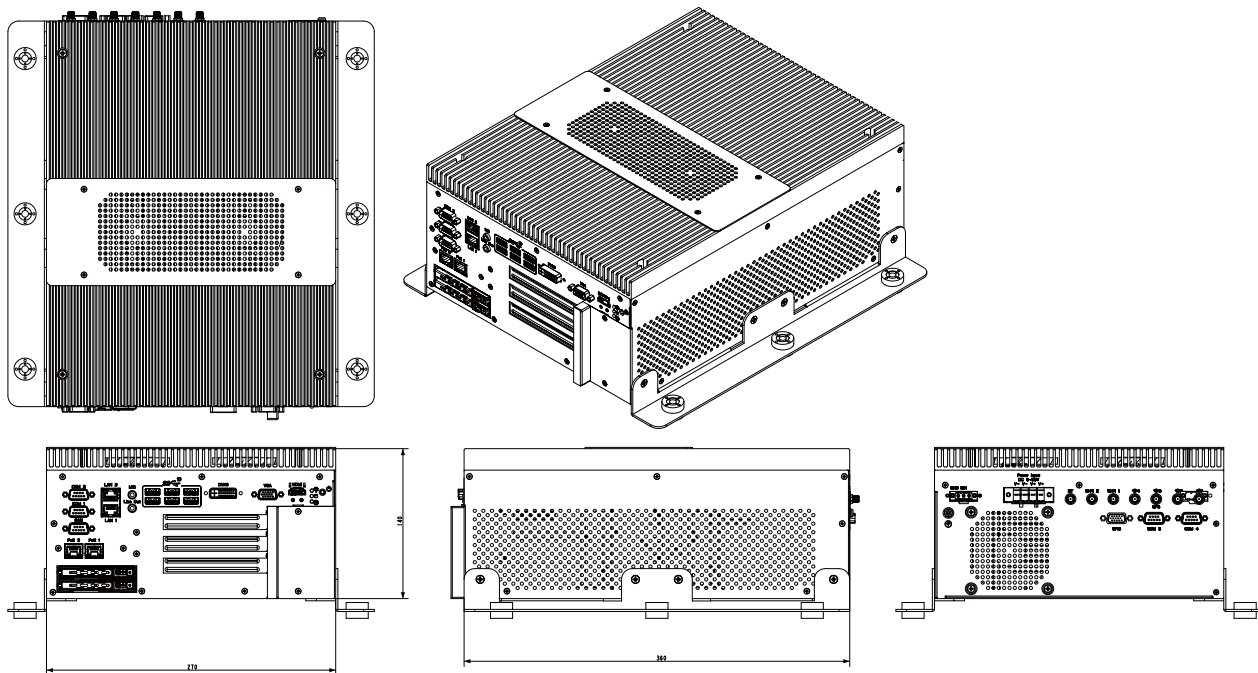

I/O Connectors

Packing List

- 1 x AAD-W480A1/2-P
- 2 x Wall mount bracket
- 1 x Terminal block
- 1 x Screws Package
- 1 x GPU fixing kit

CPU List

Series	CPU	GHz	TDP (W)	ECC RAM
Intel® Xeon®	W-1290TE	4.5	35	Yes
	W-1270E	4.8	80	
	W-1270TE	4.4	35	
	W-1250E	4.7	80	
	W-1250TE	3.8	35	
Intel® Core™	i9-10900E	4.7	65	NA
	i9-10900TE	4.5	35	
	i7-10700E	4.5	65	
	i7-10700TE	4.4	35	

Order Information

AAD-W480A1-P20	AAD-W480A1-P, Socket Type CPU Platform, 2 PCIe, CANBus, PoE
AAD-W480A2-P20	AAD-W480A2-P, Socket Type CPU Platform, 2 PCIe, CANBus, PoE, With System Fan

Optional Accessory

DDR4 32G	Certified DDR4 32GB 3200MHz RAM(Non-ECC)
DDR4 16G	Certified DDR4 16GB 3200MHz RAM(Non-ECC)
DDR4 8G	Certified DDR4 8GB 3200MHz RAM(Non-ECC)
DDR4 4G	Certified DDR4 4GB 3200MHz RAM(Non-ECC)
5G Module	5G & GNSS Module with Dual Antenna
4G Module	4G & GNSS Module with Dual Antenna
WiFi & Bluetooth Module	WiFi & Bluetooth Module with Dual Antenna

AAE-W480B

10th Gen Intel® Core™ Xeon/i9/i7 Processor (Comet Lake)
AI@Edge Autonomous in-vehicle Server Computer With 3PCIe,
Support Dual Graphic Card



Features

- Workstation-grade Platform : 10th Gen Intel® Xeon®/Core™ i9/i7 Processor (Comet Lake Socket), supports max 80W TDP CPU
- Support 2 DDR4 3200 SODIMM, up to 64GB (Non-ECC)
- Support 2 PCIe x16 With PCIe x8 Signal, 1 PCIe x4 Expansion Slots
- Could Supports 2 NVIDIA RTX 30 Series Graphics Cards (Max.320W Each card)
- CAN Bus Provide
- Two Front Easy Access 2.5" SATA III Storage Bay
- 9-55Vdc Power Input w/in-vehicle Power Ignition Control, up to 1,000W Power Input



Others

TPM	Optional By Request
Watchdog Timer	255 Levels
Smart Management	Wake on LAN, PXE supported
HW Monitor	Monitoring temperature, voltages. Auto throttling control when CPU overheats.

Software

OS Support	Windows 10, Linux
------------	-------------------

Power Requirement

Power Input	9V to 55V, DC-in
Power Interface	3-pin Terminal Block : V+, IGN, V- With Power Ignition Control

Mechanical & Environment

Dimension	TBD
Weight	TBD
Mounting	Wallmount
Operating Temperature	35W TDP CPU : -30°C to 70°C 65W TDP CPU : -30°C to 50°C 80W TDP CPU : -30°C to 40°C with system fan When Install Graphics Card: -20°C to 45°C with system fan
Storage Temp	-40°C to 85°C (-40°F to 185°F)
Humidity	5% to 90% Humidity, non-condensing
Shock	IEC 60068-2-27 SSD : 50G @ wallmount, Half-sine, 11ms
Vibration	IEC 60068-2-64 SSD : 5Grms, 5Hz to 500Hz, 3 Axis
EMC	CE / FCC class A/ E-Mark

*Please adopt wide operation temperature RAM, SSD, HDD to get better and stable system performance.

*If customer want to install CPU TDP up to 80W or high level GPU card, we will suggest to choose system sku with system fan version to get better thermal solution and system performance.

Specification

System

CPU	Intel® 10th Gen. Xeon®/Core™ i9/i7 Processor, support max 80W TDP CPU, socket type, LGA1200
Chipset	Intel® W480E
Memory	2 x 260 PIN DDR4-3200 SODIMM supports up to 64GB (Up to 32GB per socket)

Video

Graphic Controller	Intel® UHD Graphics 630
Interface	1 VGA, 1 DVI-D, 1 HDMI1.4b

Storage

SATA	2 SATA III (6Gbps) support S/W RAID 0, 1
M.2	1 M.2 Key M Socket (2280) NVMe SSD (Internal)
Storage Device	2 Front-access 2.5" SSD/HDD Tray

I/O

LAN	LAN 1 : RJ45 Type Intel® I210IT GigE LAN LAN 2 : RJ45 Type Intel® I210IT GigE LAN
Serial	4 DB9 Type RS-232/RS422/485
USB	6 Type A USB 3.2 Gen2
DIO	4DI,4DO, DB15 Type connector
Audio	1 Mic-in, 1 Line-out
CAN BUS	1 DB9 CANBus
LED	Power, HDD, Status
Button	1 Power Press Button
Antenna Hole	7 Antenna Holes

Expansion

Mini PCIe	2 x Full Size Mini PCIe Slots
M.2	1 x M.2 B Key(3042)
SIM Slot	1 SIM Slot (Internal)
PCIe Slot	2 PCIe[x16] Slot with PCIe x8 signal , 1 PCIe[x4] Slot

Dimensions

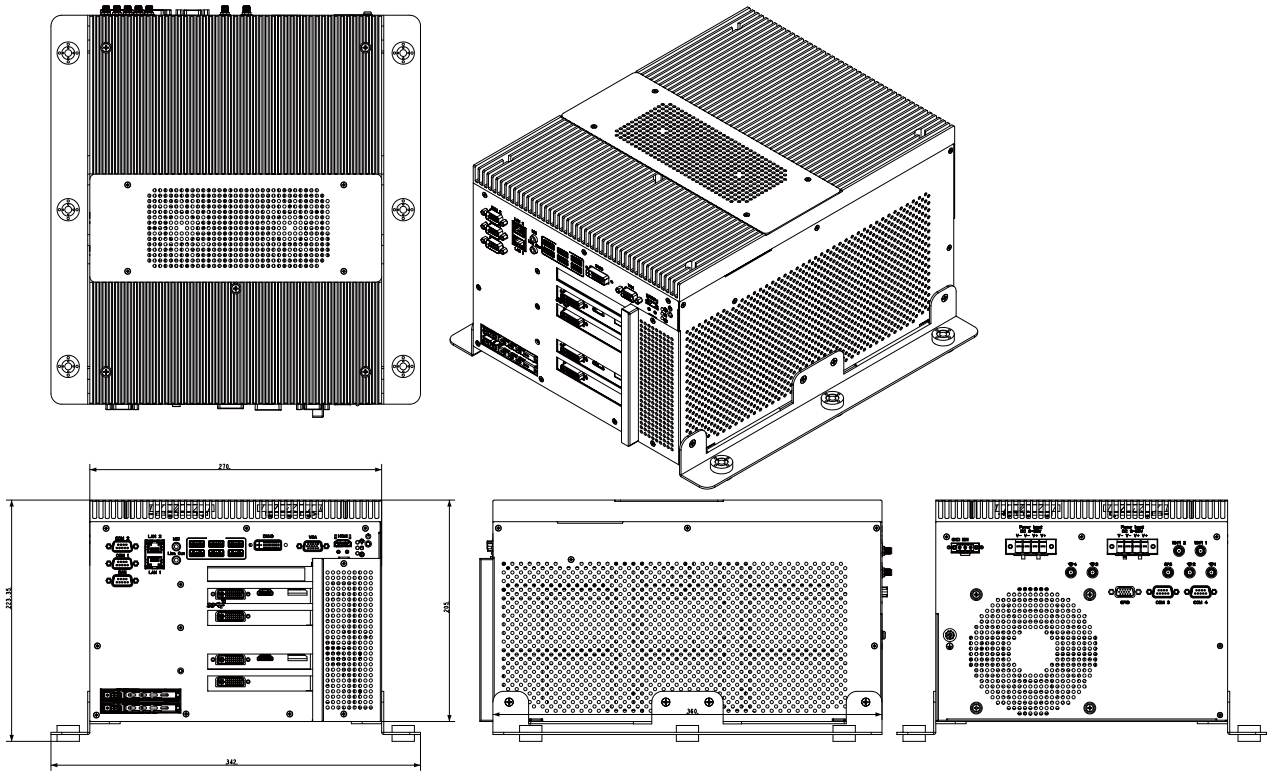

I/O Connectors

Packing List

- 1 x AAD-W480B
- 2 x Wall mount bracket
- 1 x Terminal block
- 1 x Screws Package
- 1 x GPU fixing kit

CPU List

Series	CPU	GHz	TDP (W)	ECC RAM
Intel® Xeon®	W-1290TE	4.5	35	Yes
	W-1270E	4.8	80	
	W-1270TE	4.4	35	
	W-1250E	4.7	80	
	W-1250TE	3.8	35	
Intel® Core™	i9-10900E	4.7	65	NA
	i9-10900TE	4.5	35	
	i7-10700E	4.5	65	
	i7-10700TE	4.4	35	

Order Information

AAD-W480B1-000	AAD-W480B1, Socket Type CPU Platform, 3 PCIe, CANBus
AAD-W480B2-000	AAD-W480B2, Socket Type CPU Platform, 3 PCIe, CANBus, With System Fan

Optional Accessory

DDR4 32G	Certified DDR4 32GB 3200MHz RAM(Non-ECC)
DDR4 16G	Certified DDR4 16GB 3200MHz RAM(Non-ECC)
DDR4 8G	Certified DDR4 8GB 3200MHz RAM(Non-ECC)
DDR4 4G	Certified DDR4 4GB 3200MHz RAM(Non-ECC)
5G Module	5G & GNSS Module with Dual Antenna
4G Module	4G & GNSS Module with Dual Antenna
WiFi & Bluetooth Module	WiFi & Bluetooth Module with Dual Antenna

AAAD-W480B1/2-P

10th Gen Intel® Core™ Xeon/i9/i7 Processor (Comet Lake) AI@ Edge Autonomous in-vehicle Server Computer With 3PCIe, Support Dual Graphic Card, Dual PoE For Surveillance



Features

- Workstation-grade Platform : 10th Gen Intel® Xeon®/Core™ i9/i7 Processor (Comet Lake Socket), supports max 80W TDP CPU
- Support 2 DDR4 3200 SODIMM, up to 64GB (Non-ECC)
- Support 2 PCIe x16 With PCIe x8 Signal, 1 PCIe x4 Expansion Slots
- Could Supports 2 NVIDIA RTX 30 Series Graphics Cards (Max.320W Each card)
- CAN Bus Provide, , 2 Isolated Independent PSE Ports
- Two Front Easy Access 2.5" SATA III Storage Bay
- 9-50Vdc Power Input w/in-vehicle Power Ignition Control, up to 1,000W Power Input

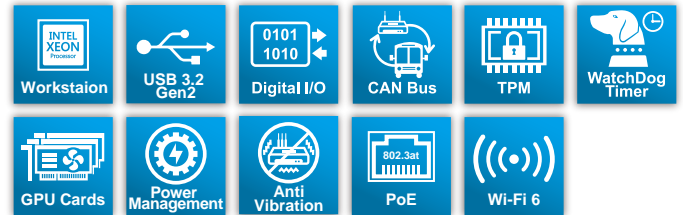

Others

TPM	Optional By Request
Watchdog Timer	255 Levels
Smart Management	Wake on LAN, PXE supported
HW Monitor	Monitoring temperature, voltages. Auto throttling control when CPU overheats.

Software

OS Support	Windows 10, Linux
------------	-------------------

Power

Power Input	9V to 55V, DC-in
Power Interface	3-pin Terminal Block : V+, IGN, V- With Power Ignition Control

Mechanical & Environment

Dimension	TBD
Weight	TBD
Mounting	Wallmount
Operating Temperature	35W TDP CPU : -30°C to 70°C 65W TDP CPU : -30°C to 50°C 80W TDP CPU : -30°C to 40°C with system fan When Install Graphics Card: -20°C to 45°C with system fan
Storage Temp	-40°C to 85°C (-40°F to 185°F)
Humidity	5% to 90% Humidity, non-condensing
Shock	IEC 60068-2-27 SSD : 50G @ wallmount, Half-sine, 11ms
Vibration	IEC 60068-2-64 SSD : 5Grms, 5Hz to 500Hz, 3 Axis
EMC	CE / FCC class A/ E-Mark

*Please adopt wide operation temperature RAM, SSD, HDD to get better and stable system performance.

*If customer want to install CPU TDP up to 80W or high level GPU card, we will suggest to choose system sku with system fan version to get better thermal solution and system performance.

Specification

System

CPU	Intel® 10th Gen. Xeon®/Core™ i9/i7 Processor, support max 80W TDP CPU, socket type, LGA1200
Chipset	Intel® W480E
Memory	2 x 260 PIN DDR4-3200 SODIMM supports up to 64GB (Up to 32GB per socket)

Video

Graphic Controller	Intel® UHD Graphics 630
Interface	1 VGA, 1 DVI-D, 1 HDMI1.4b

Storage

SATA	2 SATA III (6Gbps) support S/W RAID 0, 1
M.2	1 M.2 Key M Socket (2280) NVMe SSD (Internal)
Storage Device	2 Front-access 2.5" SSD/HDD Tray

I/O

LAN	LAN 1 : RJ45 Type Intel® I210IT GigE LAN LAN 2 : RJ45 Type Intel® I210IT GigE LAN
Serial	4 DB9 Type RS-232/RS422/485
USB	6 Type A USB 3.2 Gen2
DIO	4DI,4DO, DB15 Type connector
Audio	1 Mic-in, 1 Line-out
CAN BUS	1 DB9 CANBus
PoE	2 DJ45 Type PoE ports, Complies with IEEE 802.3af, up to 15.4W at 48V per PoE port-Complies with EN61000-4-2 (ESD) Air-15kV, Contact-8kV
Button	1 Power Press Button
Antenna Hole	7 Antenna Holes

Expansion

Mini PCIe	2 x Full Size Mini PCIe Slots
M.2	1 x M.2 B Key(3042)
SIM Slot	1 SIM Slot (Internal)
PCIe Slot	2 PCIe[x16] Slot with PCIe x8 signal , 1 PCIe[x4] Slot

Dimensions

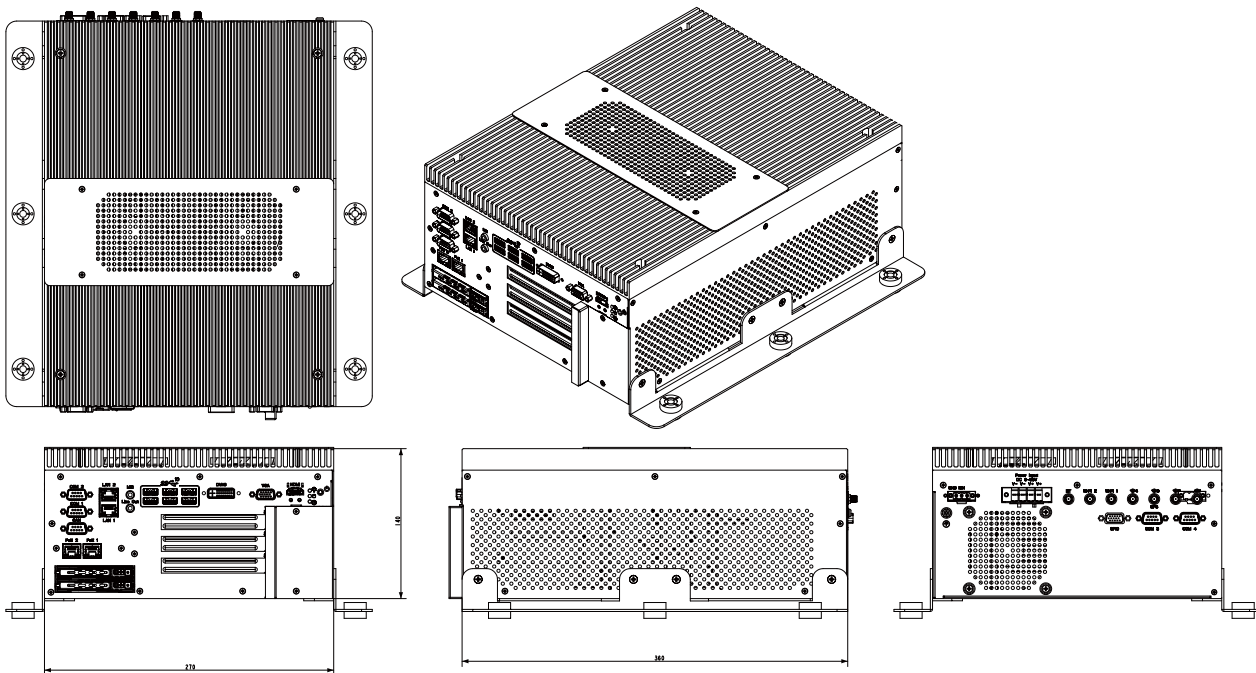

I/O Connectors

Packing List

- 1 x AAD-W480B1/2-P
- 2 x Wall mount bracket
- 1 x Terminal block
- 1 x Screws Package
- 1 x GPU fixing kit

CPU List

Series	CPU	GHz	TDP (W)	ECC RAM
Intel® Xeon®	W-1290TE	4.5	35	Yes
	W-1270E	4.8	80	
	W-1270TE	4.4	35	
	W-1250E	4.7	80	
	W-1250TE	3.8	35	
Intel® Core™	i9-10900E	4.7	65	NA
	i9-10900TE	4.5	35	
	i7-10700E	4.5	65	
	i7-10700TE	4.4	35	

Order Information

AAD-W480B1-P20	AAD-W480B1-P, Socket Type CPU Platform, 3 PCIe, CANBus, PoE
AAD-W480B2-P20	AAD-W480B2-P, Socket Type CPU Platform, 3 PCIe, CANBus, With System Fan

Optional Accessory

DDR4 32G	Certified DDR4 32GB 3200MHz RAM(Non-ECC)
DDR4 16G	Certified DDR4 16GB 3200MHz RAM(Non-ECC)
DDR4 8G	Certified DDR4 8GB 3200MHz RAM(Non-ECC)
DDR4 4G	Certified DDR4 4GB 3200MHz RAM(Non-ECC)
5G Module	5G & GNSS Module with Dual Antenna
4G Module	4G & GNSS Module with Dual Antenna
WiFi & Bluetooth Module	WiFi & Bluetooth Module with Dual Antenna

AAAD-C622A

AI Industrial Grade Autonomous Vehicle Server with 5 PCIe slots, support 3 GPU Cards

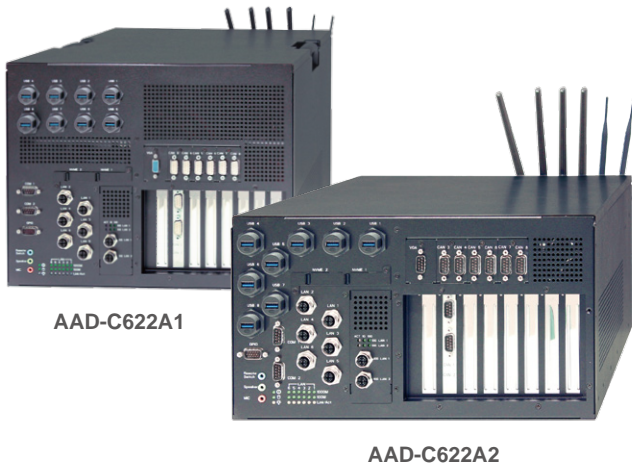

AAAD-C622A1

AAAD-C622A2

Features

- Intel® C622 Cascade Lake Platform
- Intel® 2nd Gen Xeon Scalable Processor
- 6 x RDIMM DDR4-2933
- 3 x PCIe x16 Gen3 slot (x8 signal), 2 x PCIe x16 Gen3 slot (x4 signal)
- 1,000W power board design to supports 3 NVIDIA graphics cards
- 8 x Anti-loosening USB3.2 (13/16"-28 UN type female Connector)
- 6 x M12 X-coded GbE LAN, 2 x M12 X-coded 10GbE LAN
- 2 x M.2 NVME swappable SSD bay, 2 x 2.5" SATA-III internal Storage Bay,
- 12Vdc or 24/48Vdc Power Input, Ignition Power Control

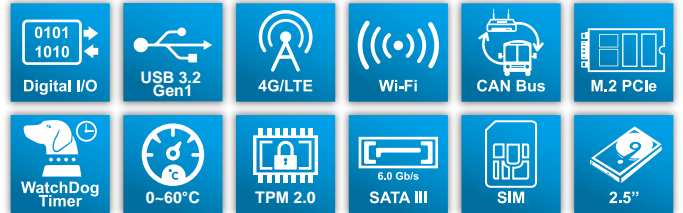

Others

WatchDog Timer	1-255 sec. software programmable(0=Disable)
Security	TPM 2.0 (Infineon chipset)

Software

OS Support	Ubuntu 18.04.LTS.
------------	-------------------

Power Requirement

Power Input	AAAD-C622A1 : 12Vdc power input with power ignition control, max. 1,000W AAAD-C622A2 : 24/48Vdc Power Input with power ignition control, max. 1,200W
-------------	---

Mechanical & Environment

Dimension	AAAD-C622A1 : 359*280*510 mm without wall mount kit AAAD-C622A2 : 359*200*510 mm without wall mount kit
Operating Temp.	-20 ~ 60°C with GPU cards
Chassis	Metal Enclosure
Thermal Design	Smart Cooling Fan
Storage Temp	-40~80°C (-40~176°F)
Safety	CE / FCC class B / E Mark / cULus / RoHS
Vibration	IEC 60068-2-64, 5~500Hz, 3GRMS(CF/SSD)
Shock	IEC 60068-2-27, 50G 500m/s ² 11MS

Specification

System

CPU	Intel®2nd Gen Xeon Scalable processor, (LGA3647)
Chipset	Intel® C622 PCH
Memory	6 x DDR4-2933 RDIMM (up to 384GB)

Video

Video Memory	Integrated
Video Interface	1 x VGA DB15 (Optional Accessory : ADB-VGA2)

Storage

SATA	2 x SATA III internal SSD bay
NVME	2 x NVME swappable SSD bay

I/O

Ethernet	6 x M12 X-coded I210-IT GbE LAN, 2 x M12 X-coded X550-AT2 10GbE LAN (By optional accessory kit)
USB	8 x Anti-loosening USB3.2 (13/16"-28 UN type female Connector)
Serial Port	2 x COM – DB9 (RS232/RS422/485)
CAN Bus	Expand by optional accessory kit. - CAN FD module (DB9 type) - CAN 2.0 (DB9 type)
GPIO	4 in/ 4 out, DB9
Audio	<ul style="list-style-type: none"> • Green: Audio out • Blue: Use for Remote on/off switch • Pink : Mic in
Mini-PCIe	1 x Full size mPCIe socket 1 x M.2 B Key 3042 type socket
Exp. PCIe slot	5 PCIe slots: - 3 x PCIe x16 Gen3 slot (x8 signal), - 2 x PCIe x16 Gen3 slot (x4 signal)
SIM Card	2 x SIM card Socket

Dimension

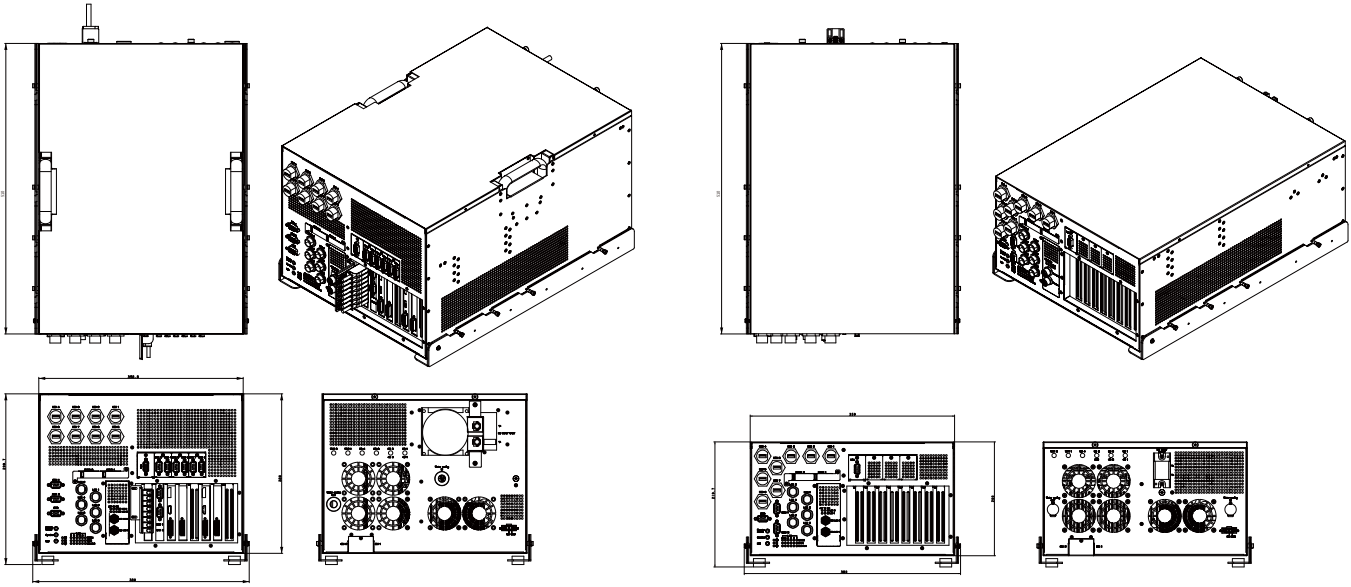

I/O Connectors

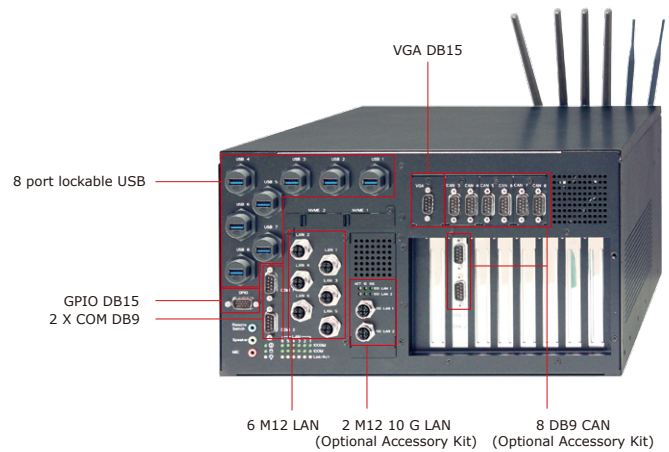
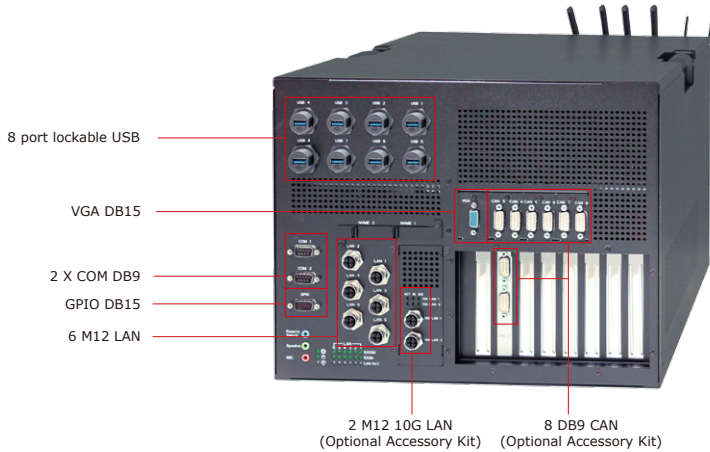

Packing List

- 1 x AAD-C622A
- 1 x Ignition Terminal Block
- 1 x System Bracket
- 6 x M12 GbE M12 X-Coded Cable
- 1 x GPU Card Retaining Set

Optional Module List

- 8/16/32GB DDR4 2933 RDIMM
- 5G + GPS + GNSS module (100070174)(SIM8202G-M2)
- Wi-Fi +BT Module (100070170)
- 2 ports M12 X-coded 10G kit (100070177)
- 8 ports CAN FD Kit (100070180)
- 8 ports CAN 2.0B kit (100070181)
- 8 port USB card =>100070172
- 1 DB15 VGA (100090084)(ADB-VGA2)

Network Security Appliance

Acrosser manufactures network appliances and network applications for your UTM and Next-Generation Firewall (NGFW). Under the x86 based structure, this Microbox Network and network appliance can perform applications from UTM appliance, rackmount server, firewall, VPN, gateway security, VOIP, SDN/NFV, vCPE, SD-WAN to bandwidth management, and intrusion detection. Acrosser provides high-quality Network Server Hardware/ Network appliances for network security applications. (Both Intel network security solution and AMD network security solution). Currently, Acrosser supplies customers with 2 main network products: 2U/1U Rackmount and Micro Box or desk-top network. These high-quality network server hardware and network appliances are ideal for network security hardware and network communication applications. All products feature scalable platforms including Intel Atom, Core 2 Duo, Core I with single core up to quad-core.

Network Application Scenario

From enterprises to SMBs, all IT Managers need less devices to solve more problems 24/7.



Intrusion Prevention



Anti-Spam



Firewall



Anti-Virus



VPN



Web Filtering



VOIP

ANR-ICEDA1

Intel® Xeon D-1713NT Processor
1U Network Security Appliance

2.5" SSD/HDD



SD-WAN White-box solution

(VPN, UTM, uCPE and SD-WAN solutions.)

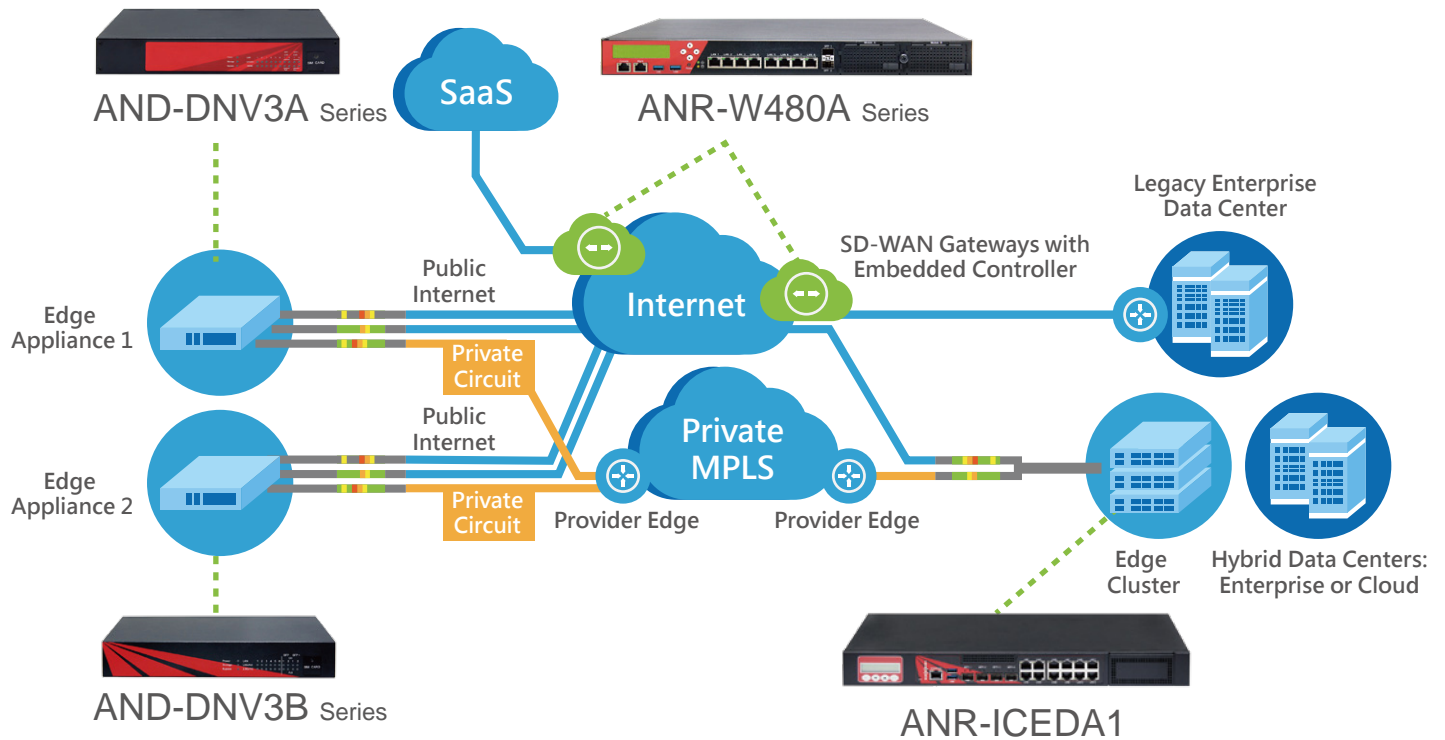

Product Matrix

Network Security Appliance



Form Factor		1U Rackmount	1U Rackmount
Model Name		ANR-C621A1	ANR-ICEDA1
System	CPU type	2 x 3rd Gen Intel® Xeon® Scalable Processors (Intel IceLake-SP)	Intel® Xeon® ICE-Lake-D LCC Processor
Chipset	Chipset	Intel® C621A PCH Chipset	Intel® SoC
Memory	Technology	16 x 288Pin DDR4 RDIMM, up to 3200 MT/s, Max up to 512GB	2 x DDR4 288 Pin SO-DIMM ECC DIMM slots
	Maximum support	-	-
Ethernet	SFP+ GbE	-	4
	RJ45 GbE	2	12
	Bypass	-	2
Expansion	PCIe	1	2
	Mini PCIe	-	-
	Networking Module	8 x Exp. NIM (1G/10G/40G, Fiber / Copper / Bypass)	1 x Exp. NIM (1G/10G/40G, Fiber / Copper / Bypass)
LCM	LCM	LCM with Keypad	LCM with Keypad
Storage	HDD	2 x 2.5" SATA Storage (Internal)	2 x 2.5" SSD/HDD Tray
	SATA	-	2 x SATA III
I/O	Console	1 x RJ45	1 x RJ45
	LED	Power LED, Status LED, Active LED	Power LED, Status LED, Active LED
	USB	2 x USB 3.0	2 x USB 3.0 (front-side), 2 x USB 2.0 (rear-side)
	Dimension	438mm x 660mm x 88mm	430mm x 200mm x 44mm
Thermal	PWM Smart Cooling Fan	PWM Smart Cooling Fan	
Reference page		34	34

Product Matrix

Network Security Appliance



Form Factor		1U Rackmount	
Model Name		ANR-W480A	ANR-C246E1
System	CPU type	Intel® 10th Gen Comet Lake-S Xeon W, Core™ i9 / i7 / i5 / i3	Intel® 8/9th Gen Coffee Lake-S Xeon E, Core™ i7 / i5 / i3
Chipset	Chipset	Intel® W480E PCH	Intel® C246 PCH
Memory	Technology	4 x UDIMM DDR4	2 x SO-DIMM DDR4
	Maximum support	-	-
Ethernet	SFP+	0/0	-
	RJ45 GbE	9/9	8
	Bypass	2/2	2
Expansion	PCIe	0/1	-
	Mini PCIe	-	1
	Networking Module	2 x Exp. NIM (1G/10G/40G, Fiber / Copper / Bypass)	.2 x Exp. NIM (1G/10G/40G, Fiber/Copper/LAN Bypass)
LCM	LCM	Graphic LCM	Graphic LCM
Storage	HDD	2 x 2.5" SATA III	2 x 2.5"/3.5" SATA-III
	mSATA	-	1 x mSATA
	M.2	1 x M.2	-
I/O	Console	1 x RJ45, 1 x mUSB	1 x RJ45
	Video out	VGA	HDMI
	USB	2 x USB 3.2 (front-side)	2 x USB 3.2 Gen1.(Front-Side)
Dimension		440mm x 44mm x 470mm	430mm x 44mm x 200mm
Thermal		PWM Smart Cooling Fan	PWM Smart Cooling Fan
Reference page		36	38

Network Security Appliance



Form Factor		1U Rackmount	
Model Name		ANR-SKB1N	ANR-SKB2N
System	CPU type	Intel® 7th Gen CPU Kabylake-S Core™ i7-7700 / i5-7500 Intel® 6th Gen CPU Skylake-S Pentium™ G4400	Intel® Xeon® Processor E3-1268 v5 / E3-1275 v6 Intel® 7th Gen CPU Kabylake-S Core™ i7-7700 Intel® 6th Gen CPU Skylake-S Pentium™ G4400
Chipset	Chipset	Intel® H110 PCH	Intel® C236 PCH
Memory	Technology	2 x UDIMM DDR4-2666, non-ECC	2 x UDIMM DDR4-2666, non-ECC,
	Maximum support	32GB	32GB
Ethernet	SFP GbE	-	2
	RJ45 GbE	6	6
	Bypass	3	3
Expansion	PCI-e	-	1
	M.2	-	-
	Networking Module	1/2 x Exp. NIM	1/2 x Exp. NIM
LCM	LCM	-	-
Storage	HDD	2 x 2.5" HDD Bay	2 x 2.5" HDD Bay
	CF / CFast / mSATA	1 x CFast socket / 1 x mSATA socket	1 x CFast socket / 1 x mSATA socket
I/O	Console	1 x RJ45	1 x RJ45
	Video out	HDMI 1.4	HDMI 1.4
	USB	2 x USB 3.0	2 x USB 3.0
Dimension		440mm x 44mm x 358mm	440mm x 44mm x 358mm
Thermal		2 x Smart cooling fan	2 x Smart cooling fan
Reference page		40	42

Product Matrix

Network Security Appliance



Form Factor		1U Rackmount
Model Name		ANR-DNN3N3
System	CPU type	Intel® Atom® C3958 Processor / Intel® Atom® C3858 Processor Intel® Atom® C3758 Processor / Intel® Atom® C3558 Processor
Chipset	Chipset	Intel® Denverton SoC
Memory	Technology	4 x ECC DIMM DDR4
	Maximum support	-
Ethernet	SFP / SFP+ GbE	1 SFP, 2/4 SFP+
	RJ45 GbE	9
	Bypass	2
Expansion	PCI-E	-
	Networking Module	1 x Exp. NIM (1G/10G/25G/40G Fiber/Copper/LAN Bypass)
LCM	LCM	Graphic LCM
Storage	HDD	3 x 2.5" SATA-III Hot-swappable(Drive bay)
	CF / CFast / M.2	1 x CFast socket
I/O	Console	RJ45 / micro-USB
	Video out	VGA
	USB	2 x USB 3.1
Dimension		430mm x 44mm x 400mm
Thermal		2 x smart cooling fan
Reference page		44

Network Security Appliance



Form Factor		Desktop	Desktop
Model Name		AND-DNV3B	AND-DNV3A
System	CPU type	Intel® Atom® C3338/C3558/C3758 Processor	Intel® Atom® C3558/C3758 Processor
Chipset	Chipset	Intel® SoC	Intel® Denverton SoC
Memory	Technology	1 x DDR4 Non-ECC SODIMM	1 x So-DIMM DDR4
	Maximum support	-	-
Ethernet	SFP / SFP+ GbE	2 SFP, 2 SFP+(B2/B3)	2 SFP, 2 SFP+
	RJ45 GbE	6	6
	Bypass	1	-
Expansion	Mini PCIe	-	-
	M.2	1 x M.2E 2 x M.2B	1 x M.2 1 x M.2B
Storage	HDD	1 x 2.5" SATA-III	1 x 2.5" SATA-III
	EMMC	-	Optional on board eMMC 32GB or 64GB
	NVME	1 x M.2 2242/2280 B key	M.2 M key socket for 2242/2260/2280 NVME SSD(For A3)
	CF / CFast	-	-
I/O	Console	1 x RJ45	1 x RJ45
	Video out	-	-
	USB	2 x USB 3.0	2 x USB 3.2 Gen1
Dimension		270mm x 44mm x 160mm	270mm x 44mm x 160mm
Thermal		Fanless Design	Fanless Design(For AND-DNV3A2)
Reference page		46	48

Product Matrix

Network Security Appliance



Form Factor		Desktop	Desktop
Model Name		AND-DNV3N1	AND-DNV3N3
System	CPU type	Intel® Atom C3558/C3308 Processor	Intel® Atom C3758/C3558/C3338 Processor
Chipset	Chipset	Intel® Denverton SoC	Intel® Denverton SoC
Memory	Technology	1 x So-DIMM DDR4	1 x SO-DIMM DDR4(C3338) / 2 x SO-DIMM DDR4(C3558,C3758)
	Maximum support	-	-
Ethernet	SFP+ GbE	2	2/4
	RJ45 GbE	4	8
	Bypass	1	1
Expansion	PCIe	-	-
	Mini PCIe	1	2
Storage	SSD Bay	1x 2.5" SSD bay	-
	HDD	-	1 x 2.5" SATA-III
	CF / CFAST / M.2	1 x M.2B	1 x CFAST socket / 1 x M.2
I/O	Console	1 x RJ45	1 x RJ45 / 1 x mUSB
	Video out	-	VGA
	USB	2 x USB 3.0	2x USB 3.0
Dimension		250mm x 44mm x 165mm	300mm x 44mm x 201mm
Thermal		Fanless	Smart cooling fan(C3758)/Fanless(C3338, C3558)
Reference page		50	52

Network Security Appliance



Form Factor		Desktop	Desktop
Model Name		AND-EL6KE1	AND-APL1E
System	CPU type	Intel®Celeron® J6412 Processor	Intel®Atom E3940/Intel®Celeron N3350
Chipset	Chipset	Intel®Elkhart Lake SoC	-
Memory	Technology	1 x So-DIMM DDR4	On board 2GB LPDDR4 memory, Optional 1x SO-DIMM slot
	Maximum support	-	8GB
Ethernet	SFP GbE	1	-
	RJ45 GbE	4	4
	Bypass	-	1(for N3350)
Expansion	PCIe	-	-
	Mini PCIe	-	1 (for E3940)
	M.2	1 x M.2B	-
Storage	HDD	1 x 2.5" SATA-III	1 x 2.5" HDD Bay, 1 x 2.5" SATA-III
	EMMC	-	On board 8GB eMMC
	mSATA	1 x mSATA socket	-
I/O	Console	1 x RJ45	1 x RJ45
	Video out	HDMI	-
	USB	2 x USB 2.0	2 x USB 3.2 Gen1
Dimension		210mm x 44mm x 105mm	165mm x 40mm x 92mm
Thermal		Fanless	Smart cooling fan
Reference page		54	56

Product Matrix

Network Interface Module

ACC-NM1Z1-01C8B

1G Copper x8 (RJ-45 w/ 4-pair Bypass)

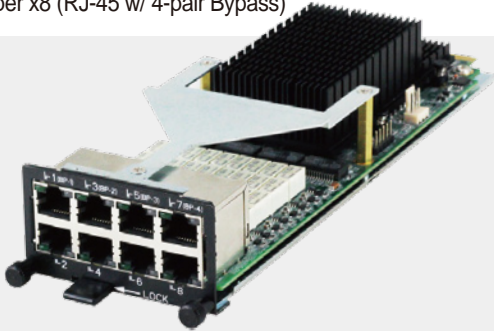

ACC-NM1Z1-01C8

1G Copper x8 (RJ-45)

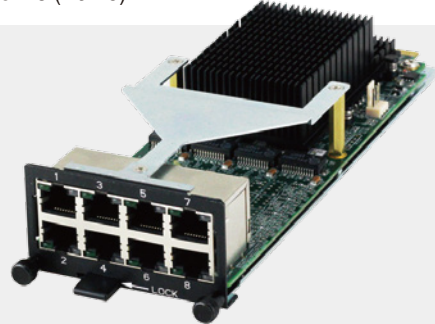

ACC-NM1Z1-01F8

1G Fiber x8(SFP)

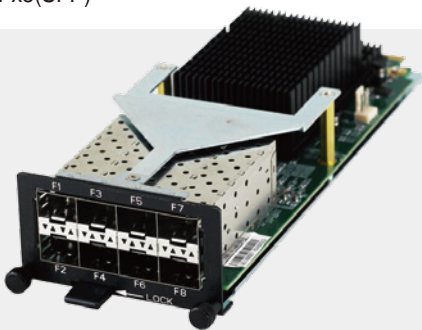

ACC-NM1Z1-01H8B

1G Hybrid x8 (SFP x4 + RJ-45 x4 w/ 2-pair Bypass)



ACC-NM1Z1-01H8

1G Hybrid x8 (SFP x4 + RJ-45 x4)

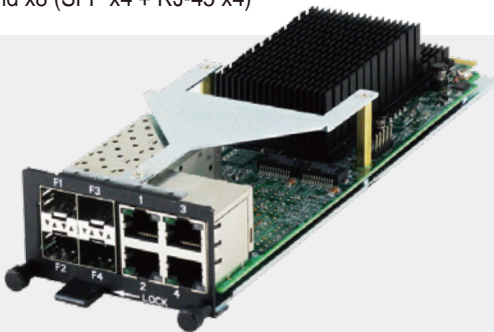

ACC-NM1Z1-10F2

10G Fiber x2 (SFP+)



ACC-NM1Z1-10F4

10G Fiber x4 (SFP+)



ACC-NM1Z1-40F2

40G Fiber x2 (QSFP+)



ANR-C621A1

2U Network Appliance with Dual 3rd Gen Intel® Xeon® Scalable Processors With 8 NIM Slots



Features

- Support Dual 3rd Gen Intel® Xeon® Scalable Processors (Intel IceLake-SP)
- Support 16x DDR4 RDIMM, Max. 512GB
- Support 8x NIM modules
- 1x PCI-E x16 expansion slot(Optional)
- 1200-Watt 1+1 redundant power supply

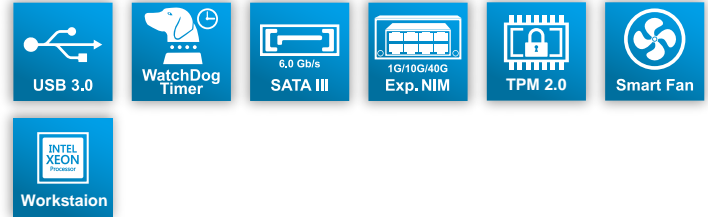

Specification

System

CPU	Support 2 x Intel® Xeon® Ice Lake-SP Processors Dual Socket, Socket Type: LGA4189 TDP: Max. 165 Watts
Chipset	Intel® C621A PCH Chipset
Memory	16 x 288Pin DDR4 RDIMM, up to 3200 MT/s, Max up to 512GB Note1: 1. Support 8 Channels per CPU; Total 16 channels for Dual CPU, Max. Capacity:256 GB per CPU (32GB/DIMM; DDR4 RDIMM) 2. Primary slot (black color) must be populated per CPU socket
BIOS	AMI
WatchDog Timer	Software programmable 0~255 sec

Ethernet

Connector	2 x GbE RJ-45(As MGMT Ports)(Intel I210-AT) Note 2: - 1 (MGMT-2) for LAN Function - 1 (MGMT-1) for MGMT ports (bottom) w/ LAN Function
LAN bypass	N/A

Storage

HDD Bay	2 x 2.5" SATA Storage(Internal)
---------	---------------------------------

I/O

Front I/O connector	3 x LED Indicators 2 x GbE RJ-45 (As MGMT Ports) 1 x RJ45 Type Console 2 x USB 3.0 Reset Button 8 x NIM Slots
Back I/O connector	Power Input Power Switch Button 1 x VGA (Optional Kit By Expansion I/O Board)
Expansion Slot	8 x NIM Slots 1 x PCI-E x16 slot (8-lane)(Internal) 1 x M.2 M Key 2280/2242 (Support SATA 3.0 or PCIe signal)

Video

Video interface	1 x VGA (Optional Kit By Expansion I/O Board)
-----------------	---

Others

OS support	Windows Server 2016/2019 LTSC, Linux Ubuntu 20.04
LCM	Support 1 x LCM @ 2 x 16 characters
Hardware Monitoring	CPU Volt. CPU & SYS Temp. FAN Speeds
TPM	Infineon SLB9670VQ2.0

Mechanical & Environment

Dimensions	438 (W) x 660 (D) x 88 (H) mm 17.24" (W) x 25.98" (D) x 3.46" (H)
Weight	21.0 kg (46.3 lbs)
Operating Temp.	0°C to 40°C
Storage Temp.	-20°C to 70°C
Relative Humidity	5 to 90% @40°C, non-condensing
Certification	CE/FCC class A

Power Requirement

DC input	Full range 1200W 1+1 redundant power
----------	--------------------------------------

Dimension

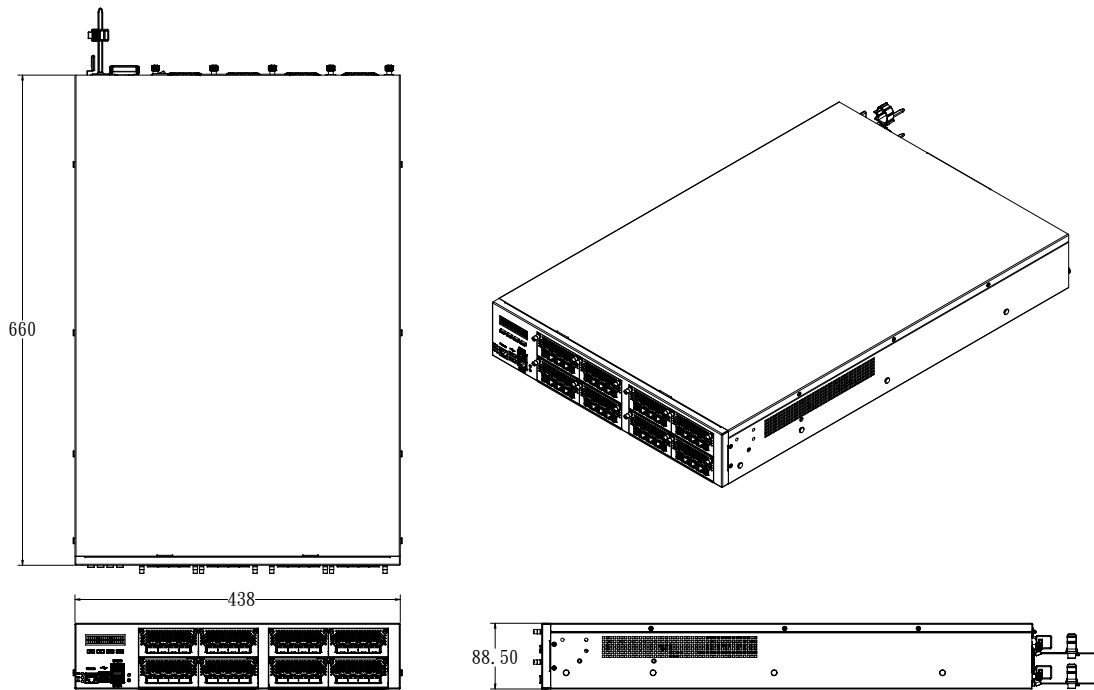

I/O Connectors

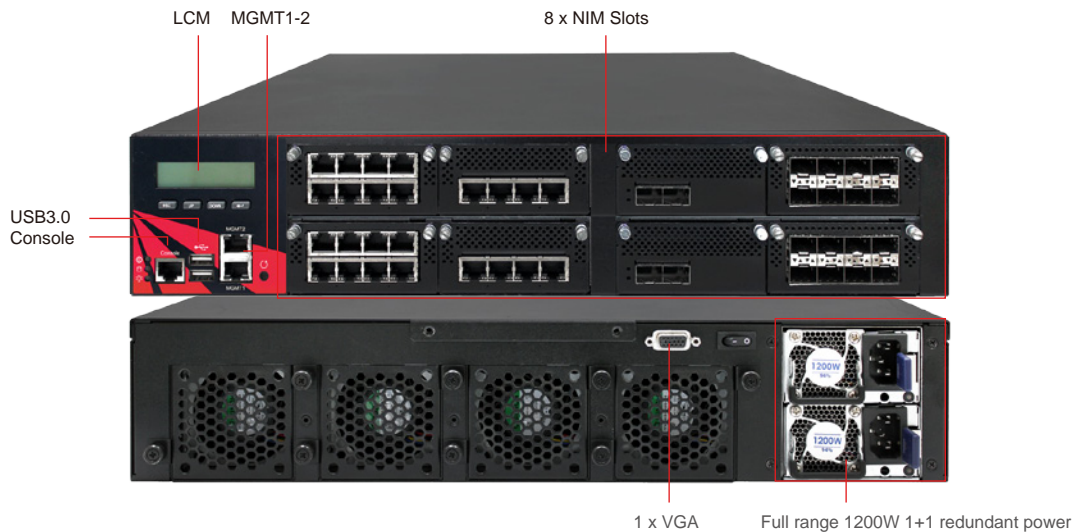

Packing List

- ANR-C621A1 System x 1
- Console cable, 160cm x 1

Ordering Information

ANR-C621A1	2U Network Appliance with Dual 3rd Gen Intel® Xeon® Scalable Processors With 8 NIM Slots, 1+1 1200W Redundant power
ACC-NM1ZB-01C8	8 x RJ45 Type GbE w/ 4 pairs Bypass (2 x Intel i350-AM4)
ACC-NM1ZB-01F8	8 x SFP type GbE(Intel® XL710-BM1)
ACC-NM1ZB-10F4	4 x SFP+ type 10GbE(Intel® XL710-BM1)

Optional Accessory

- 288 Pin DDR4 RDIMMs
- 2.5" SATA Type SSD
- VGA Module kit

ANR-ICEDA1

1U Rackmount Network Appliance With Intel Xeon D-1713NT Processor



Features

- Intel® Xeon® ICE-Lake-D LCC Processor
- 12 x 1Gb RJ45 ports
- 2 Pairs LAN Bypass
- 1 x NIM(Network Interface Module) slots
- Support 2 x 2.5" SATA-III Storage Devices
- 1x LCM with Keypad
- Support DPDK, QAT, SR-IOV



Specification

System

CPU	Intel® XEON D-1713NT Processor, 4C/8T, Ice Lake-D Base Frequency : 2.20 GHz, 45W
Chipset	SoC
Memory	2 x DDR4 288 Pin SO-DIMM ECC DIMM slots
BIOS	AMI

Ethernet

Ethernet port	12 x 1GbE RJ45 (I350 AM4 x 3) + 4 x 10GbE SFP+
LAN Bypass	2 Pairs LAN Bypass

Storage

SATA	2 SATA III (6Gbps)
Storage Device	2 2.5" SSD/HDD Tray

I/O

Console port	1 x RJ-45 Console
USB port	2 x Type A USB 3.2 Gen1
Expansion	1 x M.2 (B key 3052) for 4G/5G (USB3.0 + PCIe) with SIM 1 x M.2 (E key 2230) (PCIe)
LCD Module	1 x LCM with Keypad
Exp. NIM	1G/10G/40G, Fiber/Copper/LAN Bypass
LED	Power LED, Status LED, Active LED

Others

TPM	Optional By Request
Watchdog Timer	1~255
Battery	Internal RTC
Fan	1 x System Fan
Software Button	1

Power Requirement

Power Input	220W Power
QAT&DPDK	Support QAT&DPDK
SR-IOV	Support

Software

OS Support	Linux or Ubuntu 20.04.2 or above
------------	----------------------------------

Mechanical & Environment

Dimensions	16.93" x 7.87" x 1.73"(430mm x 200mm x 44mm)
Weight	TBD
Mounting	Rackmount
Operating Temperature	32°F ~ 104°F (0°C ~ 40°C)
Storage Temperature	-4°F~ 140°F (-20°C ~ 60°C)
Humidity	10%~80% relative humidity, non-condensing
Shock	10 G peak acceleration (11 m sec. duration), operation
Vibration	0.5 g rms/ 5 ~ 500Hz / operation (2.5" Hard Disk Drive)
EMC	CE / FCC class A

Dimension

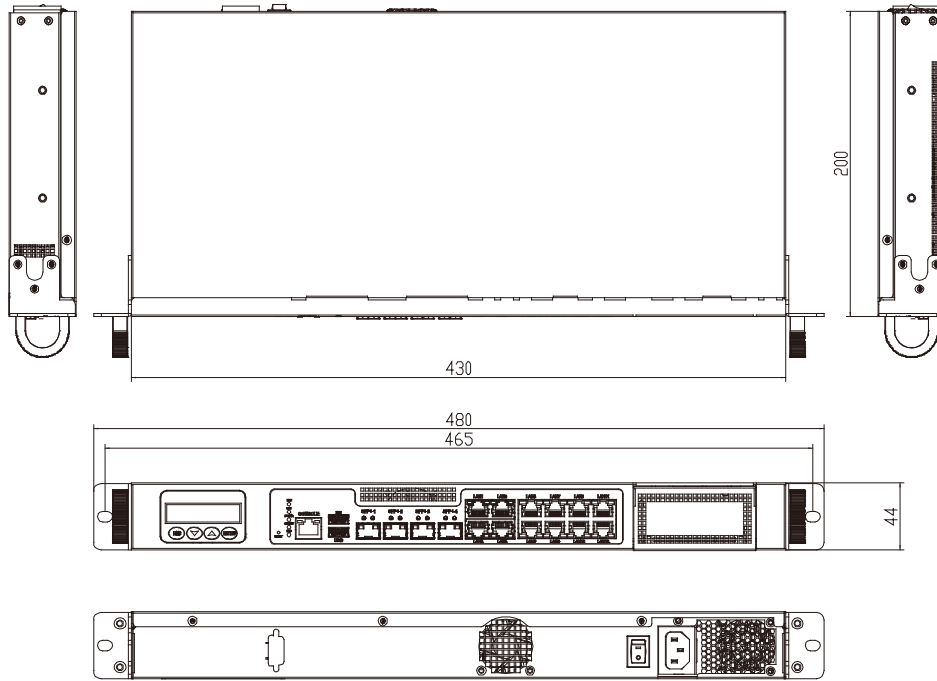

I/O Connectors

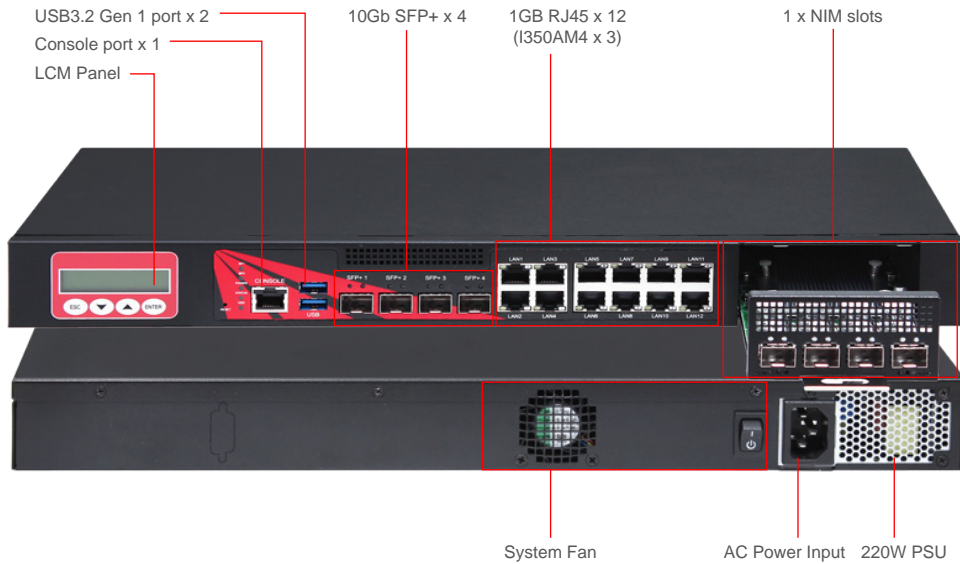

Packing List

- ANR-ICEDA1
- Console Cable
- Ear Brackets
- 2 x SATA Cable
- 2 x SATA Power Cable
- 2 x HDD brackets

Ordering Information

ANR-ICEDA1 1U Rackmount Server With Intel Xeon D-1713NT CPU

Optional Accessory

DDR4 32G	Certified DDR4 32GB 3200MHz ECC SO-DIMM
DDR4 16G	Certified DDR4 16GB 3200MHz ECC SO-DIMM
DDR4 8G	Certified DDR4 8GB 3200MHz ECC SO-DIMM
DDR4 4G	Certified DDR4 4GB 3200MHz ECC SO-DIMM
ACC-NM1ZA-01C4	Intel® 82580EB PCI-Express 1G Copper Ethernet 4 Ports Module(2Pair bypass) for ANR-ICEDA1
ACC-NM1ZA-10F4	Intel® Fortville XL710 PCI-Express 10G SFP+ 4 Ports Module for ANR-ICEDA1

ANR-W480A

1U Rackmount Network server Intel® 10th Gen Comet Lake-S Xeon W, Core™ i9, i7, i5, i3, 2 Exp. NIMs



Features

- 4 x UDIMM DDR4
- 2 x Exp. NIM (1G/10G/40G, Fiber/Copper/LAN Bypass)
- 1 x Serial Console (RJ-45)
- 2 x 1G Fiber
- 9 x GbE Copper with 2-pairs LAN Bypass
- 2 x 2.5" SATA-III
- 1 x M.2
- Optional for ATX 300W or 1+1 Redundant PSU (300W)

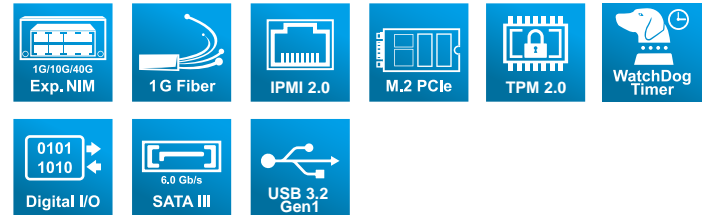

Video

Video Interface VGA(Rear-Side)

Others

Battery	Lithium Battery, 3V 220mAH (CR2032)
Hardware Monitoring	CPU Volt. CPU & SYS Temp. FAN Speeds
Security	TPM 2.0

Power Requirement

Power Unit	BOM Optional For 1x ATX PSU(300W), 100-240V or 1+1 Redundant PSU(300W), 100-240V
------------	--

Software

OS Support	Linux kernel 5.2 and above
------------	----------------------------

Mechanical & Environment

Dimensions	440(W) x 44(H) x 470(D)mm
Operating Temp.	0~ 40°C (32~104°F)
Storage Temp.	-20~80°C (-4~176°F)
Relative Humidity	0 to 90% @40°C, non-condensing
Certifications	CE, FCC Class A, RoHS 2,

Model Name

ANR-W480A1	.1U Rackmount Network Server .Intel® 10th Gen Xeon W, Core™ i9/i7/i5/i3 .2 x Exp. NIM (1G/10G/40G, Fiber/Copper/LAN Bypass) .9 x 1G GbE .2 x 1G Fiber .2 x 2.5" SATA-III .1 x M.2 .1+1 Redundant PSU (300W) or ATX PSU (300W)
ANR-W480A2	.1U Rackmount Network Server .Intel® 10th Gen Xeon W, Core™ i9/i7/i5/i3 .1 x Exp. NIM(1G/10G/40G/Copper/Fiber/LAN Bypass) .1 x Exp. NIM(1G/10G/Copper/Fiber/LAN Bypass) .9 x 1G GbE .2 x 1G Fiber .2 x 2.5" SATA-III .1x PCIe x8 slot .1 x M.2 .1+1 Redundant PSU (300W) or ATX PSU (300W)

Specification

System

CPU	Intel® Xeon® W-1290E Intel® Xeon® W-1270E Intel® Comet Lake-S Core™ i9-10900E Intel® Comet Lake-S Core™ i7-10700E Intel® Comet Lake-S Core™ i5-10500E Intel® Comet Lake-S Core™ i3-10100E
Chipset	Intel® W480E PCH
Memory	4 x UDIMM DDR4
BIOS	AMI
WatchDog Timer	Software programmable 0~255 sec.

Ethernet

Ethernet port	9 x GbE Copper (RJ-45) 2 x 1G Fiber
LAN Bypass	2-Pair Bypass -1st LAN bypass by LAN[1:2] -2nd LAN bypass by LAN[3:4]

Storage

HDD Bay	2 x 2.5"/3.5" SATA-III
M.2	1 x M.2 B key Socket 2242 or 2280

I/O

Console port	1 x Serial Console (RJ-45)
USB port	2 x USB 3.2 Gen1.(Front-Side)
Expansion	ANR-W480A1 : 2 x NIM module.(PCIe x 8)(for) ANR-W480A2 : 2 x NIM module (PCIe x 8, PCIe x 4) 1 x PCIe x 8 slot
LCD Module	16 characters x 2 lines with 4-key button(optional)
GPIO	8-bit GPIO (4-In, 4-Out), on-board pin header
Exp. NIM	2 x Exp. NIM(1G/10G/40G, Fiber/Copper/ LAN Bypass)

I/O Connectors

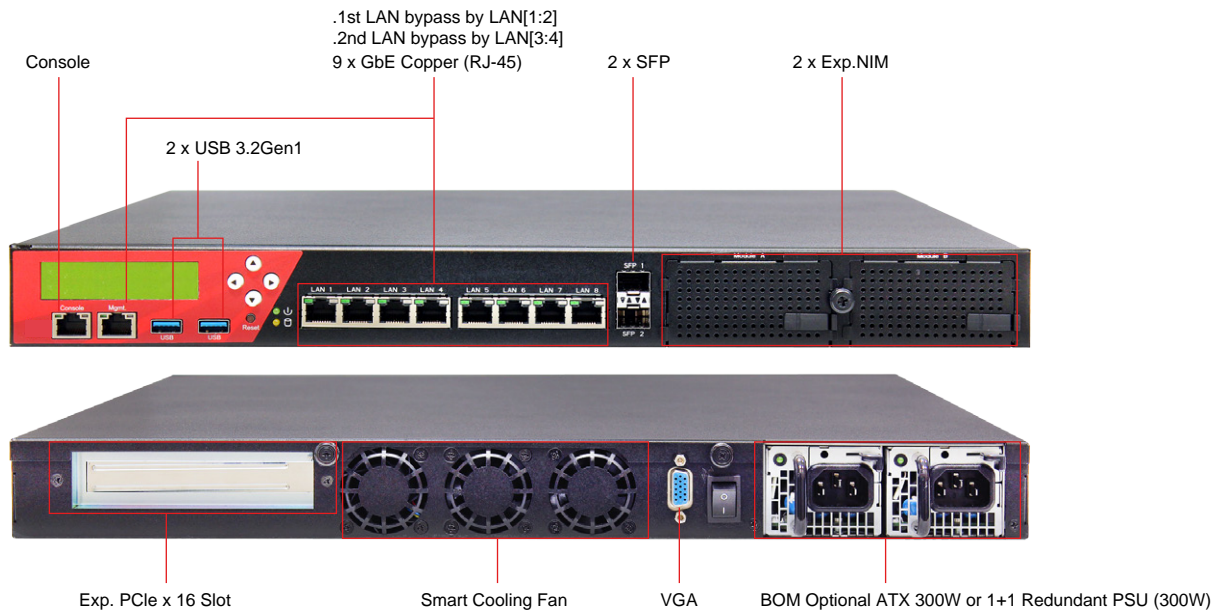

Packing List

- ANR-W480A-system x 1
- SATA cable x 2
- RJ45 console cable (RJ45 <-> DB9) x 1
- Rack bracket x 1
- Box packing x 1
- Screw pack x 1

Ordering Information

ANR-W480A1	<ul style="list-style-type: none"> .1U Rackmount Network Server .Intel® 10th Gen Xeon W, Core™ i9/i7/i5/i3 .2 x Exp. NIM (1G/10G/40G, Fiber/Copper/LAN Bypass) .9 x 1G GbE .2 x 1G Fiber .2 x 2.5" SATA-III .1 x M.2 .1+1 Redundant PSU (300W) or ATX PSU (300W)
ANR-W480A2	<ul style="list-style-type: none"> .1U Rackmount Network Server .Intel® 10th Gen Xeon W, Core™ i9/i7/i5/i3 .1 x Exp. NIM(1G/10G/40G/Copper/Fiber/LAN Bypass) .1 x Exp. NIM(1G/10G/Copper/Fiber/LAN Bypass) .9 x 1G GbE .2 x 1G Fiber .2 x 2.5" SATA-III .1x PCIe x8 slot .1 x M.2 .1+1 Redundant PSU (300W) or ATX PSU (300W)

ANR-C246E1

1U Rackmount Network server Intel® 8/9th Gen Coffee Lake-S Xeon E, Core™ i7, i5, i3, 1 Exp. NIM



Features

- Intel® 8/9th Gen Xeon E, Core™ i7/i5/i3
- 2 x SO-DIMM DDR4
- 1 x Exp. NIM (1G/10G/40G, Fiber/Copper/LAN Bypass)
- 8 x GbE Copper (RJ-45)
- 2 x 2.5" SATA-III
- 1 x mPCIe/mSATA socket

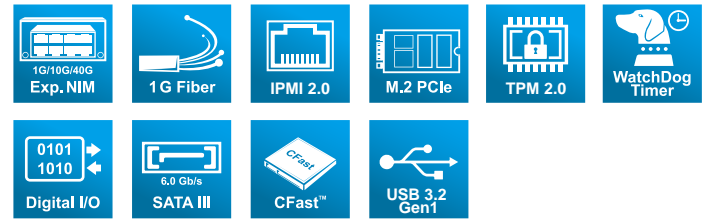

Specification

System

CPU	Intel® Xeon® E-2278GE Intel® Coffee Lake-S Core™ i7-9700E Intel® Coffee Lake-S Core™ i7-8700E Intel® Coffee Lake-S Core™ i5-9500E Intel® Coffee Lake-S Core™ i3-9100E
Chipset	Intel® C246 PCH
Memory	2 x SO-DIMM DDR4
BIOS	AMI
WatchDog Timer	Software programmable 0~255 sec.

Ethernet

Ethernet port	8 x GbE Copper (RJ-45)
LAN Bypass	2-Pair Bypass

Storage

HDD Bay	2 x 2.5"/3.5" SATA-III
mSATA	1 x mSATA Socket shared with mPCIe socket

I/O

Console port	1 x Serial Console (RJ-45)
USB port	2 x USB 3.2 Gen1.(Front-Side)
Expansion	Optional 1x NIM slot
LCD Module	16 characters x 2 lines with 4-key button
GPIO	8-bit GPIO (4-In, 4-Out), on-board pin header
Exp. NIM	1G/10G/40G, Fiber/Copper/LAN Bypass

Video

Video Interface	HDMI(Rear-Side)
-----------------	-----------------

Others

Battery	Lithium Battery, 3V 220mAH
Hardware Monitoring	CPU Volt. CPU & SYS Temp. FAN Speeds
Security	Optional TPM 2.0

Power Requirement

Power Unit	1x ATX PSU(220W), 100-240V
------------	----------------------------

Software

OS Support	Linux kernel 5.2 and above
------------	----------------------------

Mechanical & Environment

Dimensions	430(W) x 44(H) x 200(D)mm
Operating Temp.	0~ 40°C (32~104°F)
Storage Temp.	-20~80°C (-4~176°F)
Relative Humidity	0 to 90% @40°C, non-condensing
Certifications	CE, FCC Class A, RoHS 2,

Model Name

ANR-C246E1	.1U Rackmount Network Server .Intel® 8/9th Gen Xeon E, Core™ i7/i5/i3 .1 x Exp. NIM (1G/10G/40G, Fiber/Copper/LAN Bypass) .8 x 1G GbE .2 x 2.5" SATA-III .1 x mSATA/mPCIe socket .ATX PSU (220W)
------------	--

Dimension

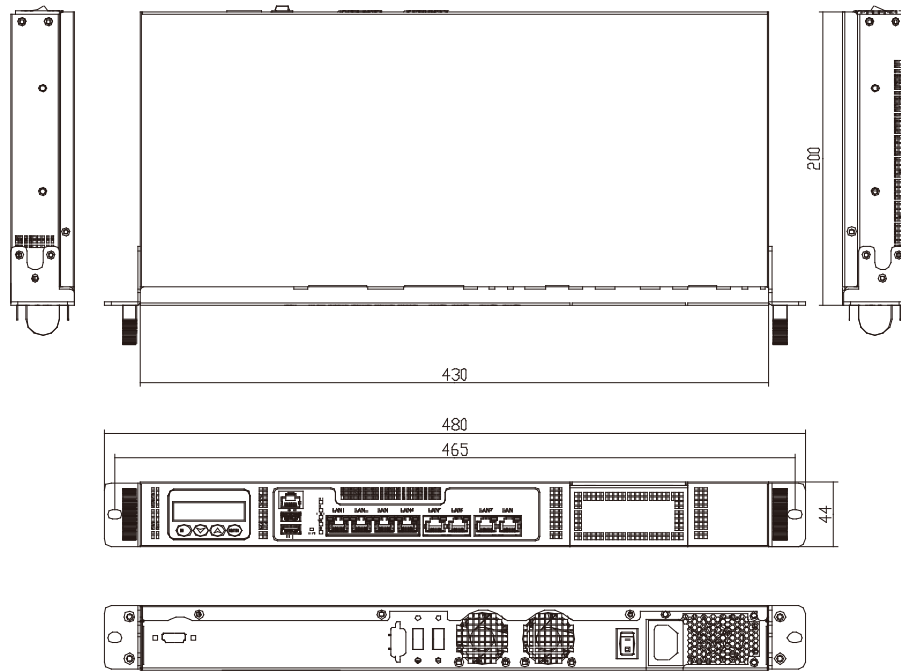

I/O Connectors

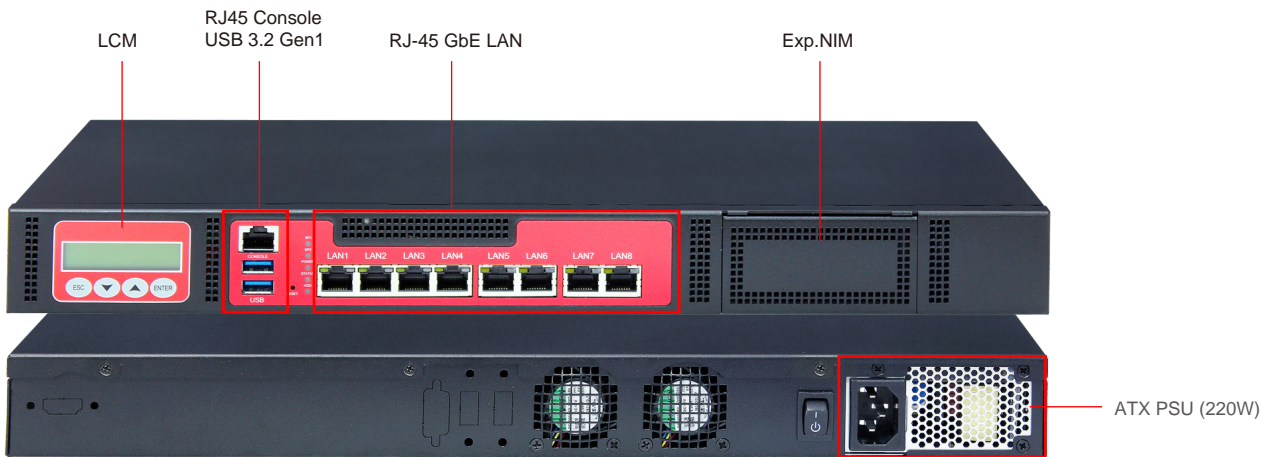

Packing List

- ANR-C246E1 system x 1
- HDD/SSD kit x 2
- RJ45 console cable (RJ45 <-> DB9) x 1
- USA / EU / JPN / UK / AS / NZS / SA / power cord x 1
- Rack bracket x 1
- Screw pack x 1

Ordering Information

ANR-C246E1

- .1U Rackmount Network Server
- .Intel® 8/9th Gen Xeon E, Core™ i7/i5/i3
- .1 x Exp. NIM (1G/10G/40G, Fiber/Copper/LAN Bypass)
- .8 x 1G GbE
- .2 x 2.5" SATA-III
- .1 x mSATA/mPCIe socket
- .ATX PSU (220W)

ANR-SKB1N

1U Rackmount Intel® PCH H110 Networking, 6 GbE LANs with Bypass



Features

- Intel® H110 Platform
- Intel® 7th Gen CPU Kabylake-S Core™ i7-7700
- 2 x UDIMM DDR4-2666, non-ECC, (up to 32GB)
- 6 x GbE Copper with Bypass
- 2 x 2.5" HDD
- 2 x Smart cooling fan

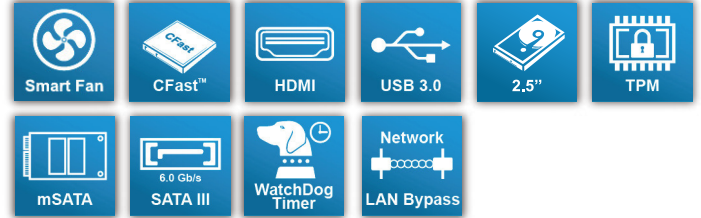

Specification

System

CPU	Intel® 7th Gen CPU Kabylake-S Core™ i7-7700 Intel® 7th Gen CPU Kabylake-S Core™ i5-7500 Intel® 6th Gen CPU Skylake-S Pentium™ G4400
Chipset	Intel® H110 PCH
Memory	2 x 288-pin UDIMM DDR4-2666, non-ECC, (up to 32GB)
BIOS	AMI
WatchDog Timer	Software programmable 0~255 sec.

Video

Video Interface	HDMI 1.4
-----------------	----------

Ethernet

Chipset	Intel® i210-IS (1000Mbps), SFP[1:2]
Connector	6x GbE Copper (RJ-45)
LAN Bypass	(1 st LAN bypass) by LAN[1:2] (2 nd LAN bypass) by LAN[3:4] (3 rd LAN bypass) by LAN[5:6]

Storage

HDD Bay	2 x 2.5" HDD Bay
mSATA	1 x mSATA socket
CF	1 x CFAST socket

I/O

Console port	1 x Serial console (RJ-45)
USB port	2 x USB 3.0 (front-side)
Exp. NIM	1/2 x Exp. NIM

Others

Battery	Lithium Battery, 3V 220mAH (CR2032)
Hardware Monitoring	CPU Volt. CPU & SYS Temp. FAN Speeds
Security & Mgmt.	TPM 2.0

Power Requirement

Power Supply Unit	Single ATX PSU (250-300W) 100-240VAC
-------------------	--------------------------------------

Software

OS Support	Linux Kernel 4.4 & above, (64-bit)
------------	------------------------------------

Mechanical & Environment

Dimensions	440 (W) x 44 (H) x 358 (D) mm
Operating Temp.	0~ 40°C (32~104°F)
Storage Temp.	-20~80°C (-4~176°F)
Relative Humidity	0 to 90% @40°C, non-condensing
Certifications	CE, FCC Class A, cULus, RoHS 2

Model Name

ANR-SKB1N1-ACN	Networking 1U Rackmount w/ Intel® H110 PCH, 6x GbE LANs w/Bypss 1 x Exp. NIM Single ATX PSU
ANR-SKB1N2-ACN	Networking 1U Rackmount w/ Intel® H110 PCH, 6x GbE LANs w/Bypss 2 x Exp. NIM Single ATX PSU

Dimensions

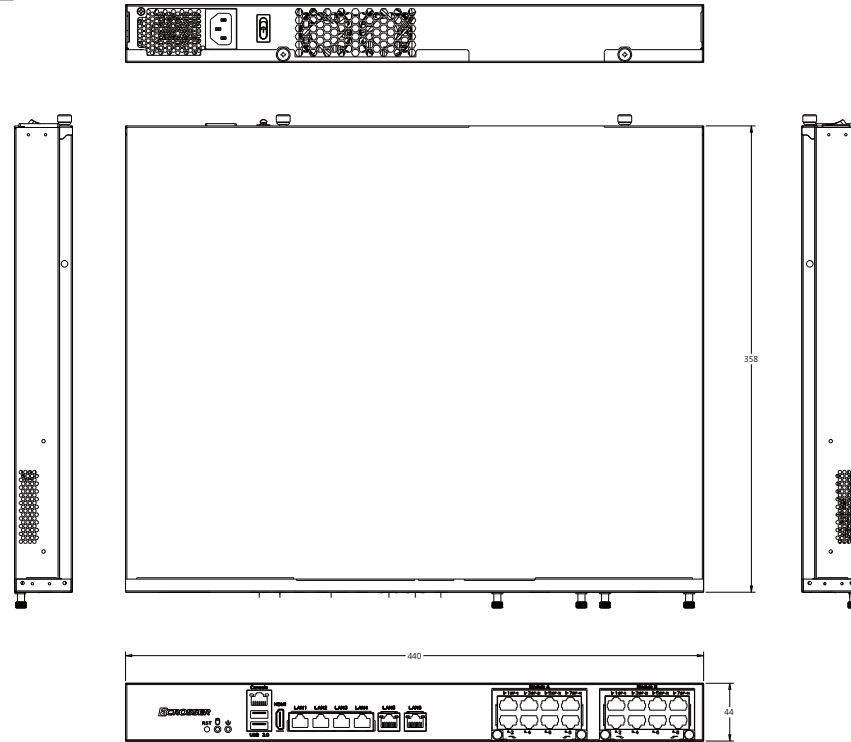

I/O Connectors

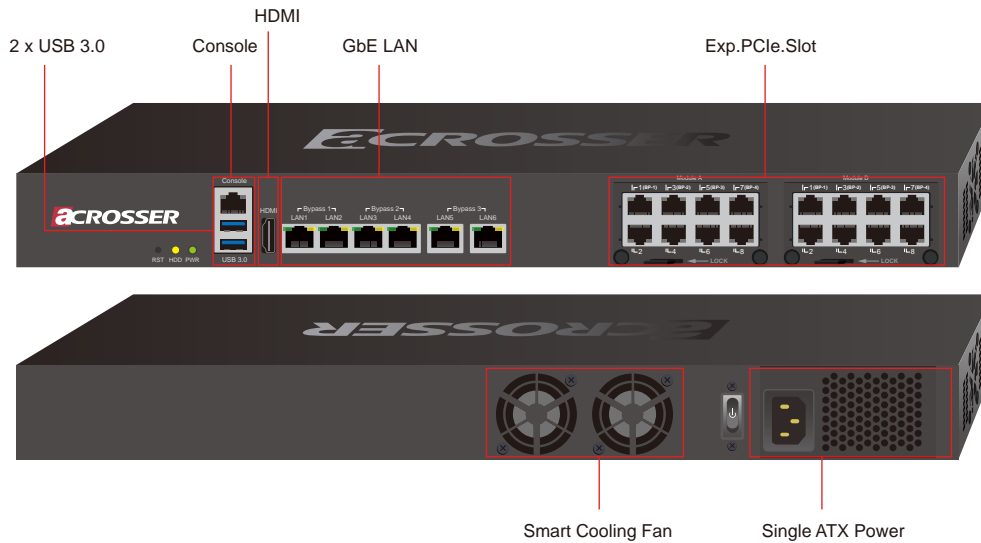

Packing List

- ANR-SKB1N-system x 1
- SATA cable x 2
- CD utility x 1
- Console cable (RJ-45 to DB9) x 1
- EU power cord x 1
- Rack bracket x 1
- Box packing x 1
- Screw for bracket (for rack + HDD bracket) x 14

Ordering Information

ANR-SKB1N1-ACN	Networking 1U Rackmount w/ Intel® H110 PCH, 6x GbE LANs w/Bypass 1 x Exp. NIM Single ATX PSU
ANR-SKB1N2-ACN	Networking 1U Rackmount w/ Intel® H110 PCH, 6x GbE LANs w/Bypass 2 x Exp. NIM Single ATX PSU

ANR-SKB2N

1U Rackmount Intel® PCH C236 Networking, 6 GbE LANs with Bypass, 2 SFP



Features

- Intel® C236 Platform
- Intel® Xeon® Processor E3-1275 v6
- Intel® 7th Gen CPU Kabylake-S Core™ i7-7700
- 2 x UDIMM DDR4-2666, non-ECC, (up to 32GB)
- 6 x GbE Copper with Byass
- 2 x 1G SFP
- 2 x 2.5" HDD
- 2 x Smart cooling fan



Others

Battery	Lithium Battery, 3V 220mAH (CR2032)
Hardware Monitoring	CPU Volt. CPU & SYS Temp. FAN Speeds
Security & Mgmt.	TPM 2.0

Power Requirement

Power Supply Unit	Single ATX PSU (250-300W) 100-240VAC
-------------------	--------------------------------------

Software

OS Support	Linux Kernel 4.4 & above, (64-bit)
------------	------------------------------------

Mechanical & Environment

Dimensions	440 (W) x 44 (H) x 358 (D) mm
Operating Temp.	0~ 40°C (32~104°F)
Storage Temp.	-20~80°C (-4~176°F)
Relative Humidity	0 to 90% @40°C, non-condensing
Certifications	CE, FCC Class A, cULus, RoHS 2

Model Name

ANR-SKB2N1-ACN	Networking 1U Rackmount w/ Intel® C236 PCH, 6x GbE LANs w/Byppss, 2x 1G Fiber 1 x Exp. NIM Single ATX PSU
ANR-SKB2N2-ACN	Networking 1U Rackmount w/ Intel® C236 PCH, 6 x GbE LANs w/Byppss, 2x 1G Fiber 2 x Exp. NIM Single ATX PSU

Specification

System

CPU	Intel® Xeon® Processor E3-1268 v5 Intel® Xeon® Processor E3-1275 v6 Intel® 7th Gen CPU Kabylake-S Core™ i7-7700 Intel® 6th Gen CPU Skylake-S Pentium™ G4400
Chipset	Intel® C236 PCH
Memory	2 x UDIMM DDR4-2666, non-ECC, (up to 32GB)
BIOS	AMI
WatchDog Timer	Software programmable 0~255 sec.

Video

Video Interface	HDMI 1.4
-----------------	----------

Ethernet

Chipset	Intel® i210-IS (1000Mbps), SFP[1:2]
Connector	6x GbE Copper (RJ-45) 2x 1G Fiber
LAN Bypass	(1 st LAN bypass) by LAN[1:2] (2 nd LAN bypass) by LAN[3:4] (3 rd LAN bypass) by LAN[5:6]

Storage

HDD Bay	2 x 2.5" HDD Bay
mSATA	1 x mSATA socket
CF	1 x CFast socket

I/O

Console port	1 x Serial console (RJ-45)
USB port	2 x USB 3.0 (front-side)
Exp. NIM	1/2 x Exp. NIM
Exp. PCIe slot	1 x Exp. PCIe x8 slot

Dimensions

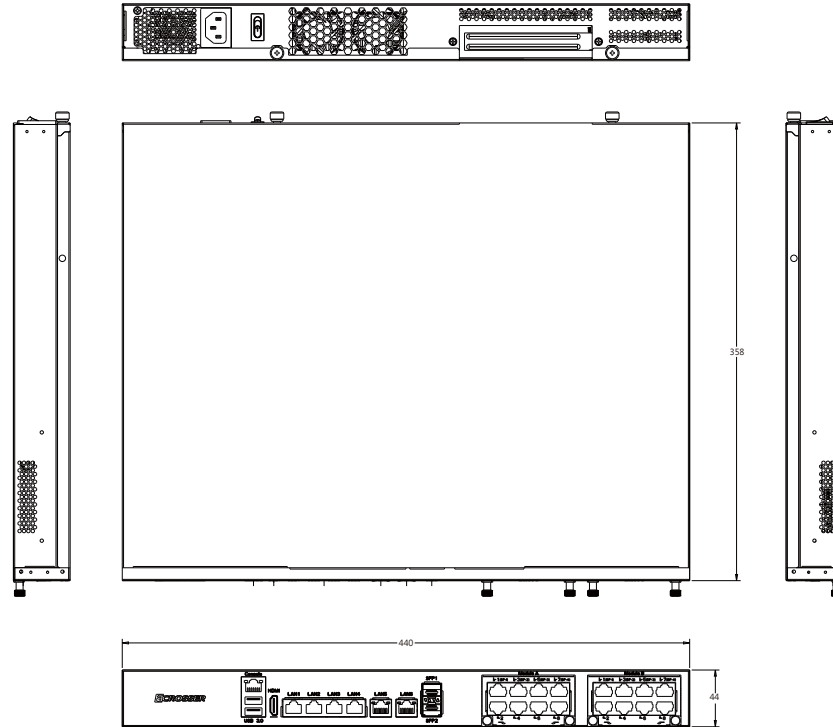

I/O Connectors

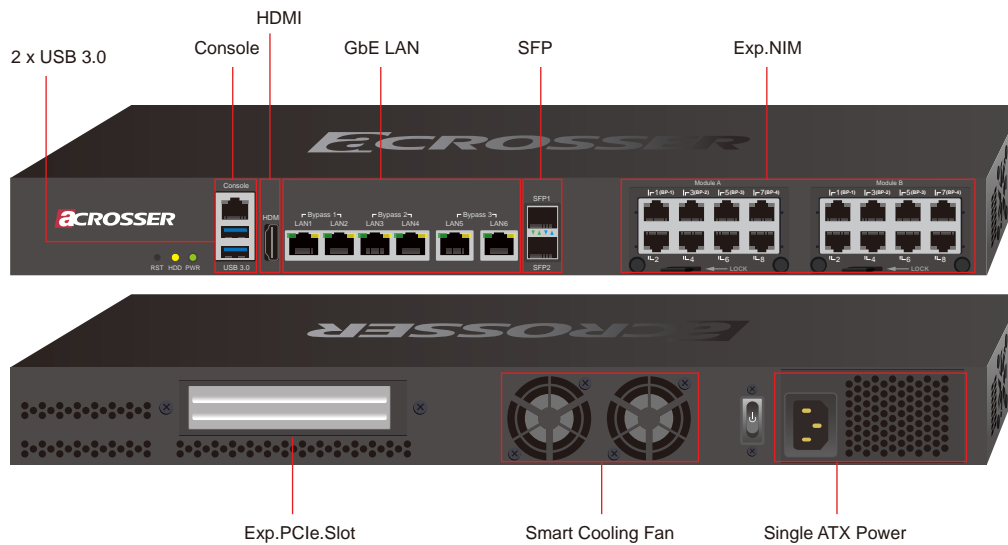

Packing List

- ANR-SKB2N-system x 1
- SATA cable x 2
- CD utility x 1
- Console cable (RJ-45 to DB9) x 1
- EU power cord x 1
- Rack bracket x 1
- Box packing x 1
- Screw for bracket (for rack + HDD bracket) x 14

Ordering Information

- | | |
|----------------|---|
| ANR-SKB2N1-ACN | Networking 1U Rackmount w/ Intel® C236 PCH,
6x GbE LANs w/Bypass, 2x 1G Fiber
1 x Exp. NIM
Single ATX PSU |
| ANR-SKB2N2-ACN | Networking 1U Rackmount w/ Intel® C236 PCH,
6 x GbE LANs w/Bypass, 2x 1G Fiber
2 x Exp. NIM
Single ATX PSU |

ANR-DNV3N3

1U Rackmount IoT Gateway/Network Micro Server Intel® Denverton Platform, 1 Exp. NIM, & 1U Redundant PSU



Features

- Intel® Denverton C3000 Platform
- 4 x UDIMM DDR4
- 1 x Exp. NIM (1G/10G/25G/40G Fiber/Copper/LAN Bypass)
- 1 x Mgmt. port
- 3 x 2.5" SATA-III Drive bay, 1 x CFast
- 2 x smart cooling fan
- ATX 250W / 1+1 Redundant PSU

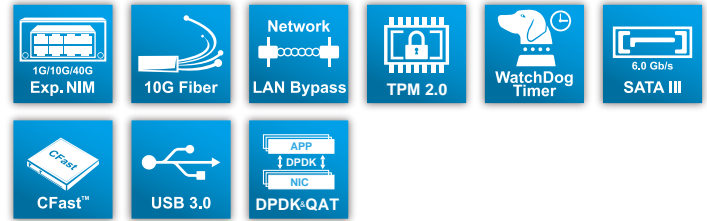

Others

Battery	Lithium Battery, 3V 220mAH (CR2032)
Hardware Monitoring	CPU Volt. CPU & SYS Temp. FAN Speeds
Security & Mgmt.	TPM 2.0 (Infineon chipset) Chassis Intrusion Detection
QAT & DPDK	Support QAT & DPDK

Power Requirement

Power Supply Unit	ATX 250W / 1+1 Redundant ATX 280W PSU
-------------------	---------------------------------------

Software

OS Support	Linux Kernel 4.8 and above, (64-bit)
------------	--------------------------------------

Mechanical & Environment

Dimensions	430 (W) x 44 (H) x 400 (D) mm
Operating Temp.	0~ 40°C (32~104°F)
Storage Temp.	-20~80°C (-4~176°F)
Relative Humidity	0 to 90% @40°C, non-condensing
Certifications	CE, FCC Class A, RoHS 2, cULus

Specification

System

CPU	Intel® Atom® C3558 Processor(4C/4T) Intel® Atom® C3758 Processor(8C/8T) Intel® Atom® C3958 Processor(16C/16T)
Chipset	Intel® Denverton SoC
Memory	4 x ECC DIMM DDR4
BIOS	AMI
WatchDog Timer	Software programmable 0~255 sec.

Video

Video Interface	VGA
-----------------	-----

Ethernet

Chipset	Intel® I210, X553
Connector	8 x GbE Copper (RJ-45) 1 x GbE/Management port 1 x GbE Fiber(SFP) 2/4 x SFP+
LAN bypass	2-pairs

Storage

HDD Bay	3 x 2.5" SATA-III Drive bay
CFast	1 x CFast socket

I/O

Console port	1 x Serial console (RJ-45)
USB port	1 x USB console (micro-USB)
LCM	Graphic LCM
GPIO	8 bit GPIO (4-In, 4-Out), on-board pin header
Exp. NIM	1 x Exp. NIM Hot-swappable (Not for C3558) (1G/10G/25G/40G, Fiber/Copper/LAN Bypass)
Expansion	1 x Exp. PCIe Gen3 x8(FHHL)(Not for C3558) (Not available if NIM is used)

Dimensions

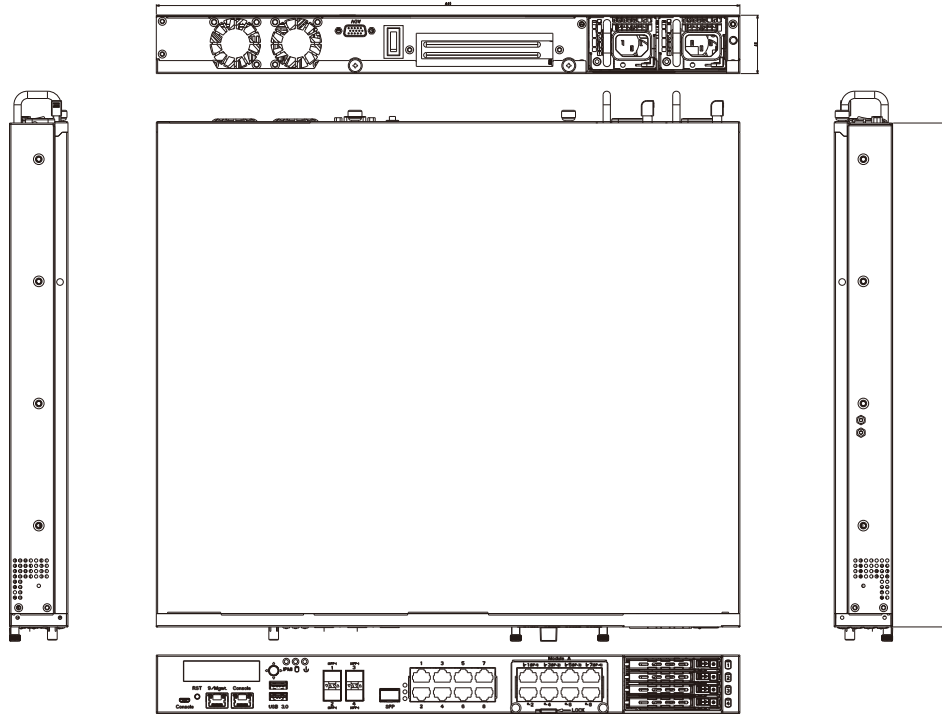

I/O Connectors

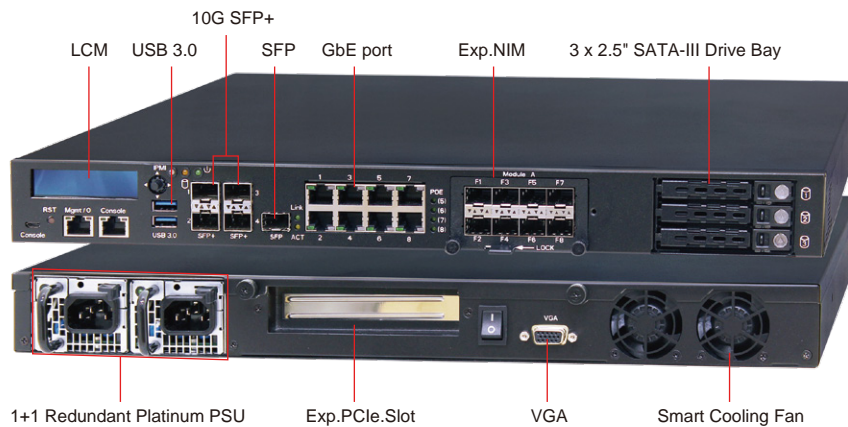

Packing List

- ANR-DNV3N3-system x 1
- Console cable (RJ-45 to Serial) x 1
- Rackmount bracket
- USA / EU / JPN / UK / AS / NZS / SA / India power cord x 1
- Screw Pack x 1

Ordering Information

ANR-DNV3N3-04	Intel Atom C3558 (4-core) Soc, 9 GbE Copper (2-pair bypass), 1 SFP and 2 SFP+, 2 USB 3.1, 3x2.5" SATA III, 1 VGA and ATX PSU.
ANR-DNV3N3-08	Intel Atom C3758 CPU, 9 GbE Copper (2-pair bypass), 1 SFP and 4 SFP+, ATX 250W.
ANR-DNV3N3-16R	Intel Atom C3958 CPU, 9 GbE Copper (2-pair bypass), 1 SFP and 4 SFP+, and 300W 1+1 Redundant PSU.

AND-DNV3B

Intel® Atom® C3000 Processor, 6 2.5GbE, 2SFP, 2SFP+ Networking Appliance



Features

- Intel® Atom® C3338R/C3558/C3758 Processor
- Support 1 x DDR4 ECC SODIMM
- Support 6 x 2.5GbE, 2 x 1GbE SFP, 2 x 10GbE SFP+
- Support 1-pair Bypass
- Optional 3G, 4G LTE, 5G, WiFi And WiFi 6

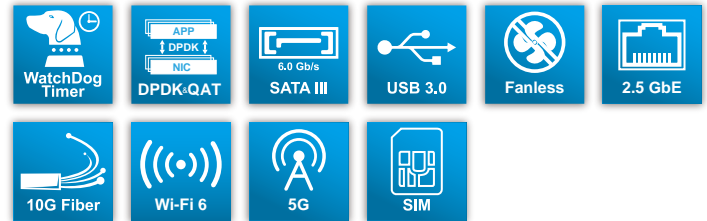

Specification

System

CPU	Intel® Atom® C3338R, 2C2T, 1.89GHz Intel® Atom® C3558, 4C4T, 2.20GHz Intel® Atom® C3758, 8C8T, 2.2GHz
Chipset	Intel® SoC
Memory	1 x DDR4 ECC SODIMM
BIOS	AMI
WatchDog Timer	Software programmable 0~255 sec

Ethernet

Chipset	Intel® I226, I210IS
Connector	6 x GbE RJ-45 & 2 x SFP(B1) 6 x GbE RJ-45 & 2 x SFP & 2 x 10GbE SFP+(B2&B3)
LAN bypass	1-pair LAN Bypass

Storage

Storage Device	1 x 2.5" SATA Storage 1 x M.2 2242/2280 B key
----------------	--

I/O

I/O connector	6 x GbE RJ-45 & 2 x SFP 2 x 10GbE SFP+ (C3558 & C3758 SKU) 2 x USB 3.0 1 x RJ45 Type Console 1 x DC-in DC Jack connectors(12V) 10 x Antenna holes Reset Button LED Indicators 2 x External Easy Access SIM Slots
---------------	--

Expansion	1 x M.2 2230 E key(For Install WiFi Module) 1 x M.2 3042/3052 B key(For Install 4G/5G Module) 1 x M.2 2242/2280/3042/3052 B key(Could Install SATA Storage/4G/5G Module) * For B1, default signal is SATA signal, you could change to signal from SATA to USB under BIOS setting
OS support	Linux Kernel 5.15 LTS & above, (64-bit)

Others

TPM	Support TPM 2.0
QAT&DPDK	Support QAT&DPDK
Cooling	Fanless : C3338R, C3558 System Fan : C3758

Mechanical & Environment

Dimensions	270 x 160 x 44mm (W x D x H)
Weight.	2.4Kg

Power Supply

DC input	DC Jack, 12Vdc 40W Adapter or DC Jack, 12Vdc 60W Adapter
----------	---

Model Name

AND-DNV3B1	Intel® Atom® C3338R 6 x 2.5GbE Copper 2 x SFP Include 12V 40W Adapter
AND-DNV3B2	Intel® Atom® C3558 6 x 2.5GbE Copper 2 x SFP, 2 x SFP+ Include 12V 40W Adapter
AND-DNV3B3	Intel® Atom® C3758 6 x 2.5GbE Copper 2 x SFP, 2x SFP+ Include 12V 60W Adapter

Dimensions

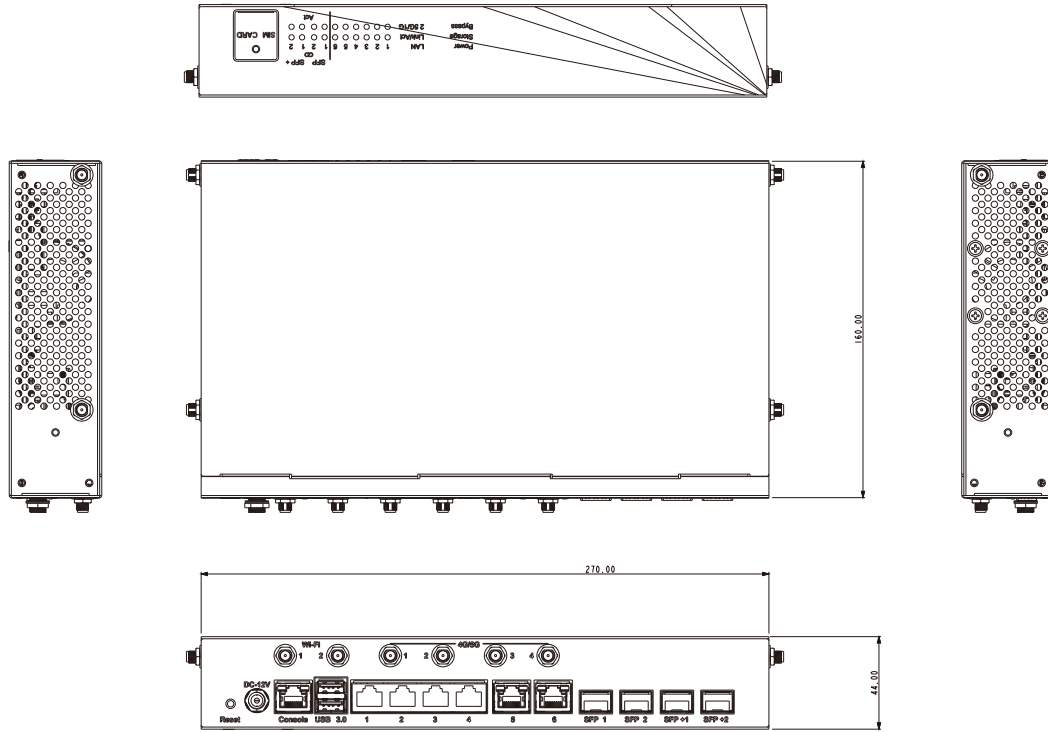

I/O Connectors

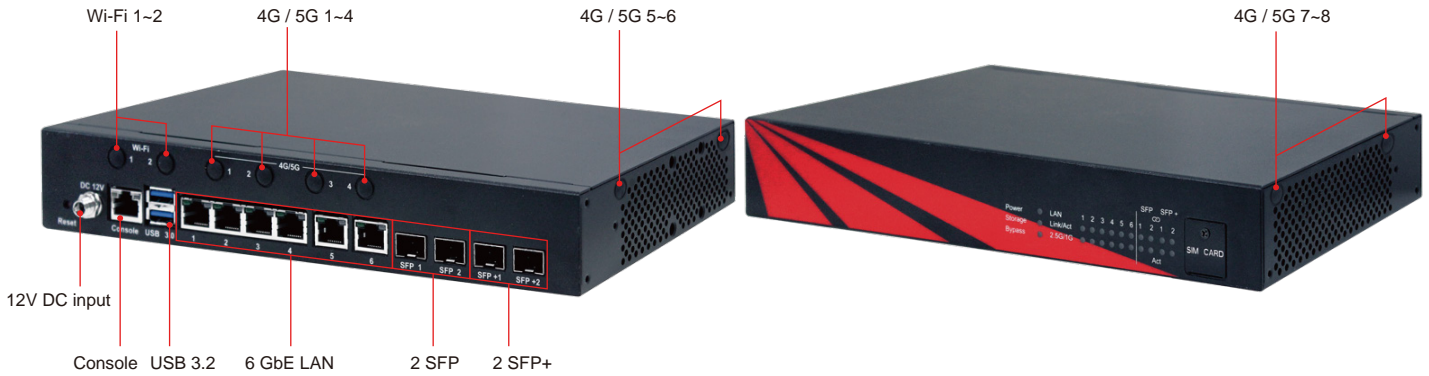

Packing List

- AND-DNV3B-system x 1
- Power Adapter(12V) x 1
- USA/EU/JPN/UK/AS/NZS/SA power cord x 1
- Screw Pack x 1

Optional Accessories

- DDR4
- WiFi module
- WiFi6 module
- 4G Module
- 5G Module

Ordering Information

AND-DNV3B1	Intel® Atom® C3338R 6x 2.5GbE Copper 2x SFP Include 12V 40W Adapter
AND-DNV3B2	Intel® Atom® C3558 6x 2.5GbE Copper 2x SFP, 2x SFP+ Include 12V 40W Adapter
AND-DNV3B3	Intel® Atom® C3758 6x 2.5GbE Copper 2x SFP, 2x SFP+ Include 12V 60W Adapter

AND-DNV3A

Intel® Denverton Platform, Desktop Networking Appliance



Features

- Intel® Denverton C3000 Platform
- 4/8 core SoC
- 1 x SO-DIMM DDR4
- 1 x 2.5" SSD Bay
- Fanless Design(For AND-DNV3A2)



Specification

System

CPU	Intel® Atom® C3558/C3758 Processor (4/8 core)
Chipset	Intel® Denverton SoC
Memory	1 x SO-DIMM DDR4
BIOS	AMI
WatchDog Timer	Software programmable 0~255 sec.

Ethernet

Chipset	Intel® I210IS
Connector	6 x GbE Copper (RJ-45) 2 x GbE Fiber (SFP) 2 x 10GbE Fiber (SFP+)

Storage

HDD Bay	1 x 2.5" SATA-III port
EMMC	Optional on board eMMC 32GB or 64GB
NVME	M.2 M key socket for 2242/2260/2280 NVME SSD (For A3)

I/O

Console port	1 x Serial console (RJ-45),
USB port	2 x USB 3.2 Gen1
Expansion	1 x M.2 Socket for optional WiFi module . 1 x M.2 B key socket for 4G/5G module, support dual SIM sockets.



Others

Battery	Lithium Battery, 3V 220mAh (CR2032)
Hardware Monitoring	CPU Volt. CPU & SYS Temp.
QAT & DPDK	Support QAT & DPDK

Power Requirement

Power Supply Unit	12V DC input 40/60W AC Adapter
-------------------	-----------------------------------

Software

OS Support	Linux Kernel 4.8 or above, (64-bit)
------------	-------------------------------------

Mechanical & Environment

Dimensions	270 (W) x 44 (H) x 160 (D) mm
Operating Temp.	0~ 40°C (32~104°F)
Storage Temp.	-20~80°C (-4~176°F)
Relative Humidity	0 to 90% @40°C, non-condensing
Certifications	CE, FCC Class A, RoHS 2,

Model Name

AND-DNV3A2	Desktop Networking Appliance Intel® Atom C3558 SoC 6 x GbE Copper 2 x SFP, 2 x SFP+ 40W AC Adapter
AND-DNV3A3	Desktop Networking Appliance Intel Atom C3758 SoC 6x GbE Copper 2x SFP, 2x SFP+ 60W AC Adapter

Dimensions

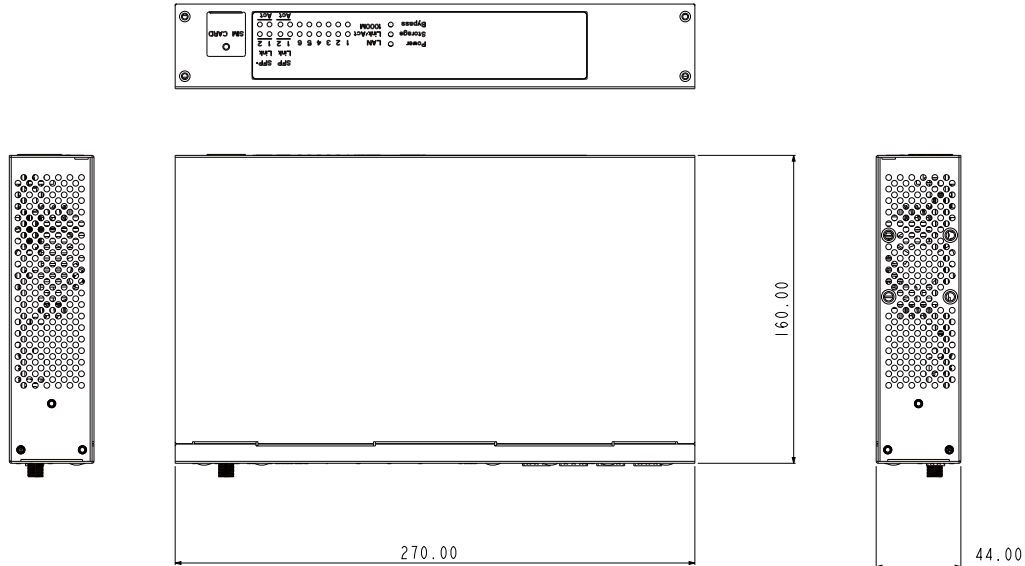

I/O Connectors

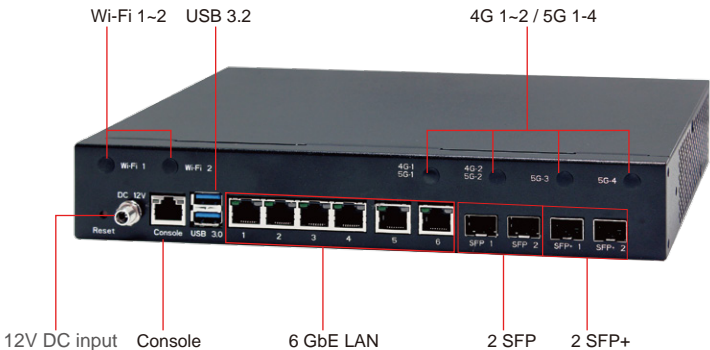
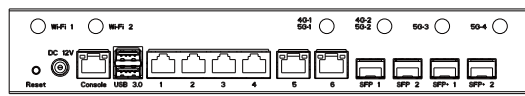

Packing List

- AND-DNV3A-system x 1
- SATA cable x 1
- USA / EU / JPN / UK / AS / NZS / SA / power cord x 1
- Box packing x 1
- Screw for bracket (HDD bracket)

Ordering Information

AND-DNV3A2	Desktop Networking Appliance Intel® Atom C3558 SoC 6 x GbE Copper 2 x SFP, 2 x SFP+ 40W AC Adapter
AND-DNV3A3	Desktop Networking Appliance Intel Atom C3758 SoC 6x GbE Copper 2x SFP, 2x SFP+ 60W AC Adapter

AND-DNV3N1

Intel® Denverton Platform, Desktop Networking Appliance



Features

- Intel® Denverton C3000 Platform
- 1 x SO-DIMM DDR4
- Fanless Design

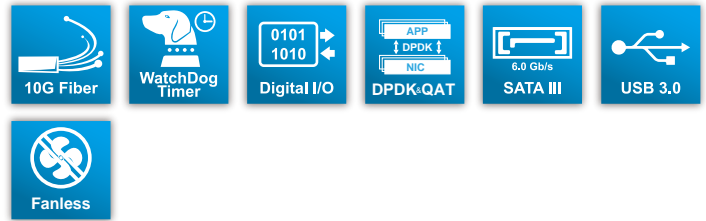

Others

Battery	Lithium Battery, 3V 220mAh (CR2032)
Hardware Monitoring	CPU Volt. CPU & SYS Temp.
Security	TPM 2.0 (Infineon chipset)
QAT & DPDK	Support QAT & DPDK

Power Requirement

Power Supply Unit	12V(40W)
-------------------	----------

Software

OS Support	Linux Kernel 4.8 or above, (64-bit)
------------	-------------------------------------

Mechanical & Environment

Dimensions	250 (W) x 44 (H) x 165 (D) mm
Operating Temp.	0~ 40°C (32~104°F)
Storage Temp.	-20~80°C (-4~176°F)
Relative Humidity	0 to 90% @40°C, non-condensing
Certifications	CE, FCC Class A, RoHS 2, cULus

Specification

System

CPU	Intel® Atom® C3308/C3558 Processor (2/4 core)
Chipset	Intel® Denverton SoC
Memory	1 x SO-DIMM DDR4
BIOS	AMI
WatchDog Timer	Software programmable 0~255 sec.

Ethernet

Chipset	Intel® i210
Connector	For C3308 sku: 4 x GbE Copper (RJ-45) For C3558 sku: 4 x GbE Copper (RJ-45) 2 x 10GbE Fiber (SFP+)
LAN Bypass	1 x pair

Storage

SSD Bay	1x 2.5" SSD bay
---------	-----------------

I/O

Console port	1 x Serial console (RJ-45),
USB port	2 x USB 2.0/3.0
Antenna port	5 x SMA for WLAN (IEEE 802.11a/b/g/n/ac)
GPIO	8-bit GPIO (4-In, 4-Out), on-board pin header
Expansion	1 x Mini PCIe Socket, For WiFi5 (for C3558) 1 x M.2B Socket with dual SIM sockets

Dimensions

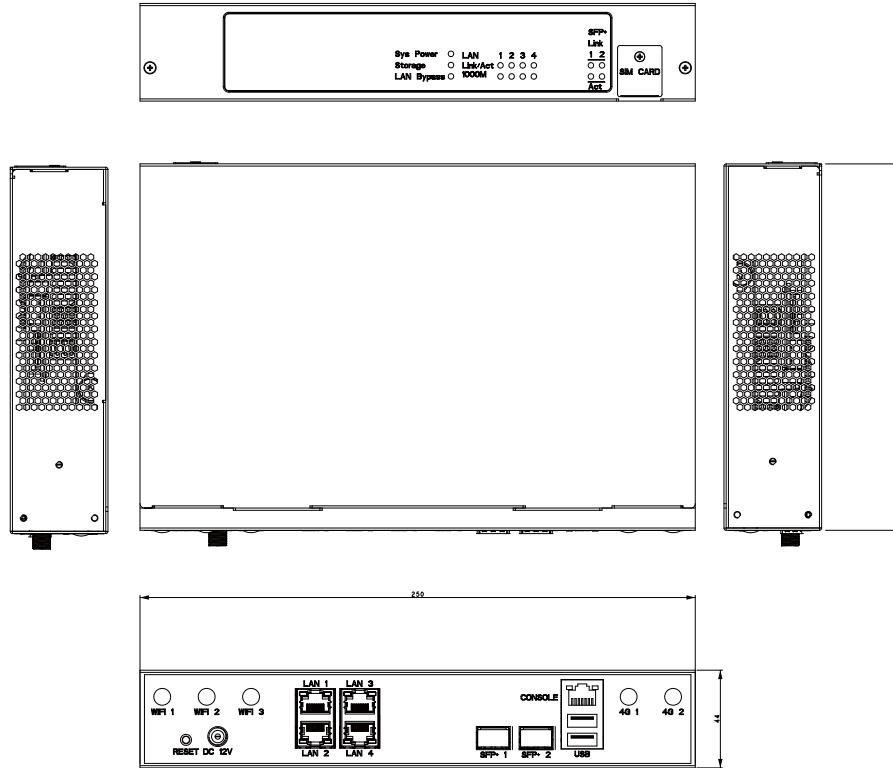

I/O Connectors

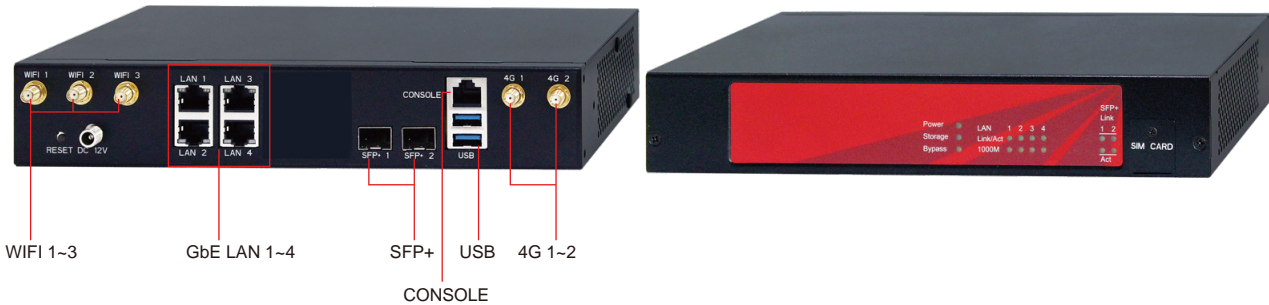

Packing List

- AND-DNV3N1-system x 1
- SATA cable x 1
- Power adapter x 1
- Screw kit x 1 set Power adapter x 1

Optional accessory kit

- DDR4 16G : Certified DDR4 16GB 3200MHz RAM
- DDR4 8G : Certified DDR4 8GB 3200MHz RAM
- DDR4 4G : Certified DDR4 4GB 3200MHz RAM
- 4G Module : 4G Module with 1 Antenna
- WiFi & Bluetooth Module : WiFi & BT Module with 3 Antennas
- Power cord : USA / EU / JPN / UK power cord

Ordering Information

AND-DNV3N1-02	Desktop Networking Appliance Intel® Denverton-NS platform 4 x GbE Copper 40W AC Adppter 1x 2.5" SSD Bay, 2x USB 2.0 1x M.2 B key socket for 4G
AND-DNV3N1-04F	Desktop Networking Appliance Intel® Denverton-NS platform 4 x GbE Copper : 2x 10GbE Fiber 40W AC adapter 1x 2.5" SSD Bay, 2x USB 3.0 1x Mini PCIe socket for WiFi 1x M.2 B key socket for 4G or SSD

AND-DNV3N3

Intel® Denverton Platform, PoE Desktop Networking Appliance



Features

- Intel® Denverton C3000 Platform
- 4/8 core SoC options
- 2 x SO-DIMM DDR4
- Support 8 x 1GbE LAN, 2/4 x 10G SFP+
- Support PoE By Module
- Dual DC-in for redundancy

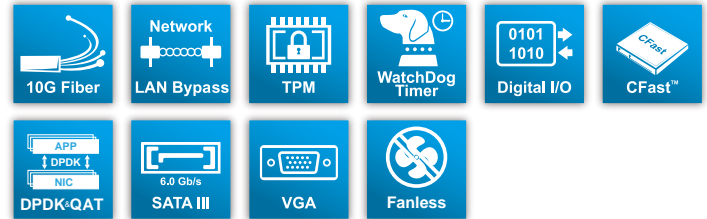

Others

Battery	Lithium Battery, 3V 220mAh (CR2032)
Hardware Monitoring	CPU Volt. CPU & SYS Temp.
Security	TPM 2.0 (Infineon chipset)
QAT & DPDK	Support QAT & DPDK

Power Requirement

Power Supply Unit	12V(40 or 60W),54V(150W)for PoE
-------------------	---------------------------------

Software

OS Support	Linux Kernel 4.8 or above, (64-bit)
------------	-------------------------------------

Mechanical & Environment

Dimensions	300 (W) x 44 (H) x 201 (D) mm
Operating Temp.	0~ 40°C (32~104°F)
Storage Temp.	-20~80°C (-4~176°F)
Relative Humidity	0 to 90% @40°C, non-condensing
Certifications	CE, FCC Class A, RoHS 2, cULus

Specification

System

CPU	Intel® Atom® C3758 Processor (8 core) Intel® Atom® C3558 Processor (4 core)
Chipset	Intel® Denverton SoC
Memory	2 x SO-DIMM DDR4(C3558,C3758)
BIOS	AMI
WatchDog Timer	Software programmable 0~255 sec.

Video

Video Interface	VGA
-----------------	-----

Ethernet

Chipset	Intel® i210, X553
Connector	AND-DNV3N3-04: 8 x 1GbE 2 x 10G SFP+ AND-DNV3N3-04P: 2 x 1GbE 6 x PoE 2 x 10G SFP+ AND-DNV3N3-08: 8 x 1GbE 4 x 10G SFP+
LAN bypass	One Pair

Storage

HDD Bay	1 x 2.5" SATA-III port
CFAST	1 x CFAST socket
M.2 NVME	1 x M.2 2280 socket (C3758 only)

I/O

Console port	1 x Serial console (RJ-45), 1 x USB console (micro-USB)
USB port	2 x USB 3.0
Antenna port	4 x SMA for WLAN (IEEE 802.11a/b/g/n/ac)&4GLTE
GPIO	8-bit GPIO (4-In, 4-Out), on-board pin header
Expansion	2 x Mini PCIe Socket, one with SIM Socket

Dimensions

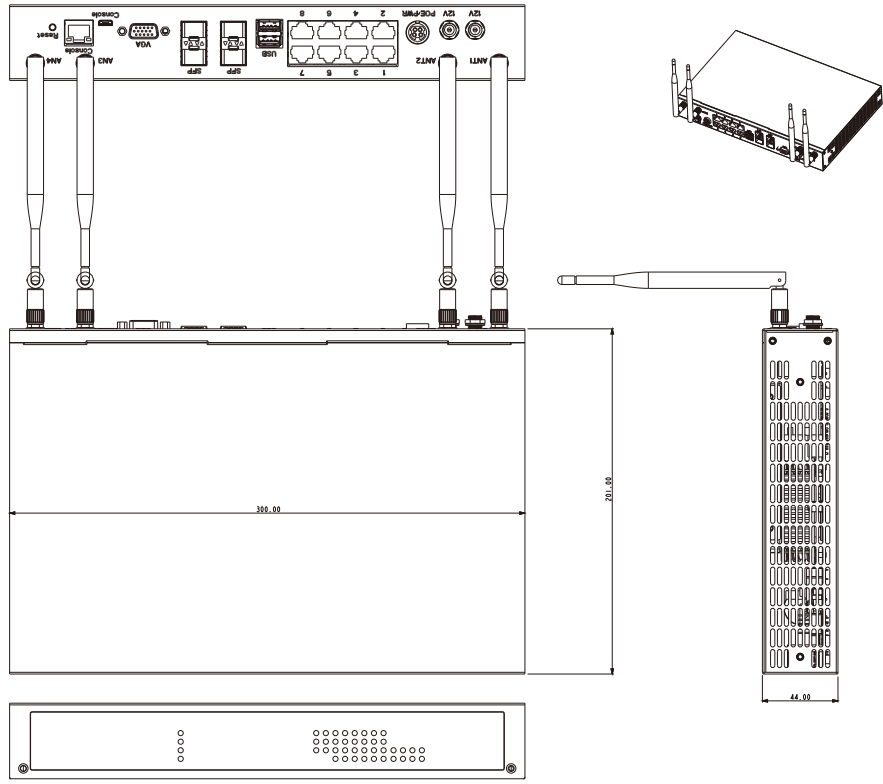

I/O Connectors

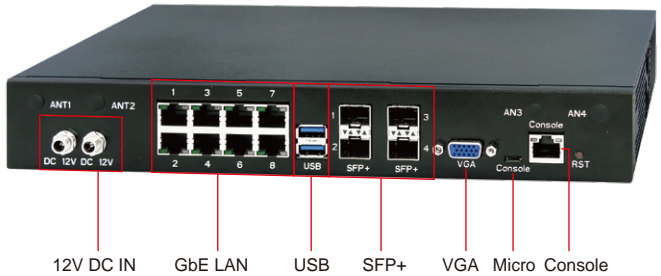

Packing List

- AND-DNV3N3-system x 1
- SATA cable x 1
- Adapter x 2
- Screw kit x 1

Optional accessory kit

- DDR4 16G : Certified DDR4 16GB 3200MHz RAM
- DDR4 8G : Certified DDR4 8GB 3200MHz RAM
- DDR4 4G : Certified DDR4 4GB 3200MHz RAM
- 4G Module : 4G Module with 1 Antenna
- WiFi & Bluetooth Module : WiFi & BT Module with 3 Antennas
- Power cord : USA / EU / JPN / UK power cord (Need to buy two cables)

Ordering Information

AND-DNV3N3-04	Intel Atom C3558 CPU, 8 GbE Copper (1-pair bypass), 2x SFP+, 2x 12V DC-In
AND-DNV3N3-04P	Intel Atom C3558 CPU, 2 GbE Copper (1-pair bypass), 6x PoE, 2x SFP+, 2x 12V DC-In and 48V DC-In.
AND-DNV3N3-08	Intel Atom C3758 CPU, 8 GbE Copper (1-pair bypass), 4 SFP+, 2x 12V DC-In

AND-EL6KE1

Intel® Elkhart Lake Platform, Desktop Networking Appliance



Features

- Intel® Elkhart Lake Platform
- 4 core SoC
- 1 x SO-DIMM DDR4
- 1 x 2.5" SSD, & 1 x mSATA
- Fanless Design
- Dual DC-in for redundancy

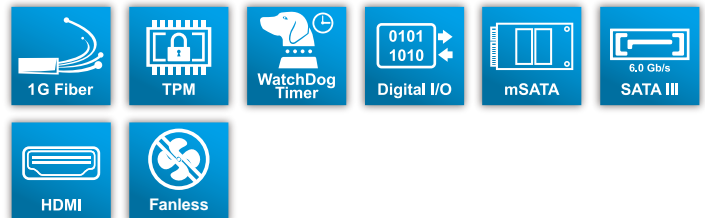

Specification

System

CPU	Intel®Celeron® J6412 Processor (4 core)
Chipset	Intel®Elkhart Lake SoC
Memory	1 x SO-DIMM DDR4
BIOS	AMI
WatchDog Timer	Software programmable 0~255 sec.

Video

Video Interface	HDMI
-----------------	------

Ethernet

Chipset	Intel® I211, i210
Connector	4 x GbE Copper (RJ-45) 1 x 1GbE Fiber (SFP)
LAN bypass	None

Storage

HDD Bay	1 x 2.5" SATA-III port
mSATA	1 x mSATA socket

I/O

Console port	1 x Serial console (RJ-45)
USB port	2 x USB
GPIO	8-bit GPIO (4-In, 4-Out), Optional on-board pin header
Expansion	Mini Card Socket (PCIe + USB 2.0, full size) with SIM x1 Mini Card Socket (PCIe, half size) x1 Optional 2nd 4/5G feature (Project base)
Antenna port	6 x SMA for WLAN&4/5GLTE

Others

Battery	Lithium Battery, 3V 220mAH (CR2032)
Hardware Monitoring	CPU Volt. CPU & SYS Temp.
Security	Optional TPM 2.0 (Infineon chip)
Crypto	AES-NI

Power Requirement

Power Supply Unit	2x DC 12V 40W Adapter
-------------------	-----------------------

Software

OS Support	Linux Kernel 4.8 or above, (64-bit)
------------	-------------------------------------

Mechanical & Environment

Dimensions	210 (W) x 44 (H) x 105 (D) mm
Operating Temp.	0~ 40°C (32~104°F)
Storage Temp.	-20~80°C (-4~176°F)
Relative Humidity	0 to 90% @40°C, non-condensing
Certifications	CE, FCC Class A, RoHS 2

Model Name

AND-EL6KE1	Desktop Networking Appliance Intel® Elkhart Lake platform 4 x GbE Copper 1 x SFP, 2x DC 12V Adapter Options for WiFi and 4G
------------	---

Dimensions

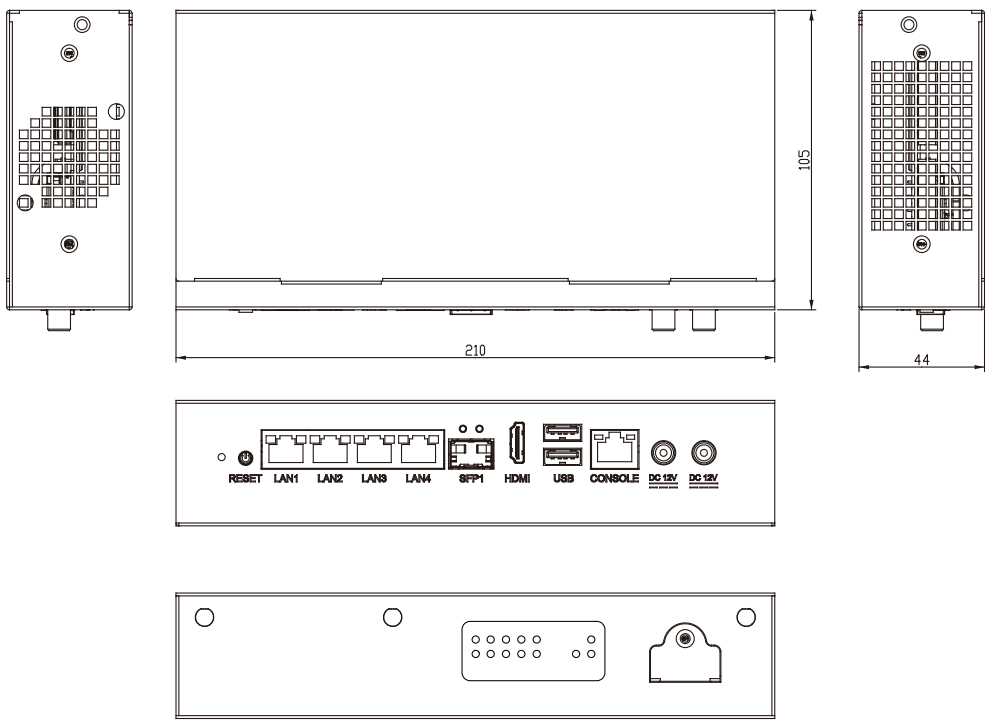

I/O Connectors

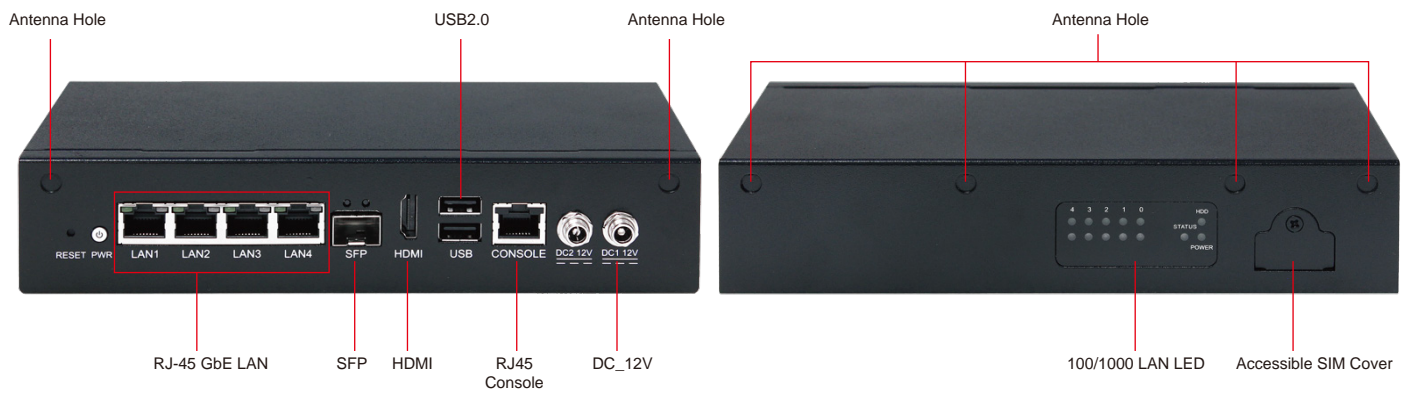

Packing List

- AND-EL6KE1 system x 1
- SATA kit x 1
- USA / EU / JPN / UK / AS / NZS / SA / India power cord x 2
- AC adapter
- Screw for bracket (for rack + HDD bracket) x 14

Ordering Information

- Desktop Networking Appliance
Intel® Elkhart Lake platform
4 x GbE Copper
1 x SFP, 1x DC 12V Adapter
Options for WiFi and 4G
- AND-EL6KE1

AND-APL1E

Intel® Apollo Lake Networking Microbox



Features

- Intel® Apollo Lake Celeron N3350, Atom E3940
- On board 2GB LPDDR4 memory, Optional 1x SO-DIMM slot
- 4 x GbE, 2 x USB 3.2 Gen1
- 1 x Mini PCIe Expansion
- 1 x 2.5" SATA 3 bay, On board 8GB eMMC



CE FC

Power Requirement

Power Input DC in 12V / Adapter

Software

OS Support Linux Kernel 4.1.27

Mechanical & Environment

Dimension 165 x 92 x 40 mm

Operating Temp. 0~40°C

Storage temp. -20~80°C

Model

AND-APL1E1 Intel Celeron N3350 Dual Core SoC
4x GbE, 1 pair LAN Bypass
2x USB 3.2 Gen1,
1x SATA3,

AND-APL1E2 Intel Atom E3940 Quad Core SoC
4x GbE,
2x USB 3.2 Gen1,
1x SATA3, 1x mPCIe for WiFi or 4G

Specification

System

CPU	1. Intel® Atom®E3940 Quad-core, clock speed 1.6GHz 2. Intel® Celeron® N3350, Dual-core, clock speed 2.41GHz
Memory	On board 2GB LPDDR4 memory. Optional 1x DDR3L SO-DIMM slot, Max. 8GB(for E3940)
BIOS	AMI UEFI
WatchDog Timer	Software programmable 1~255 sec.

Video

Graphic Controller	Integrated graphics support for processors with Intel Graphics Technology
--------------------	---

Ethernet

Chipset	4 x Intel® i210
Connector	4 x GbE RJ-45 with LED
LAN bypass	1 pair Bypass (for N3350)

Storage

SATA	1 x SATAIII port
EMMC	On board 8GB eMMC
HDD Bay	1 x 2.5" HDD Bay

I/O

Expansion	1 x Mini PCIe socket with SIM socket (for E3940)
Console Port	1 x Console (1 x RJ45)
USB	2 x USB 3.2 Gen1
Antenna Hole	Optional 2 x SMA for Wi-Fi (or 4G) (for E3940)

Dimension

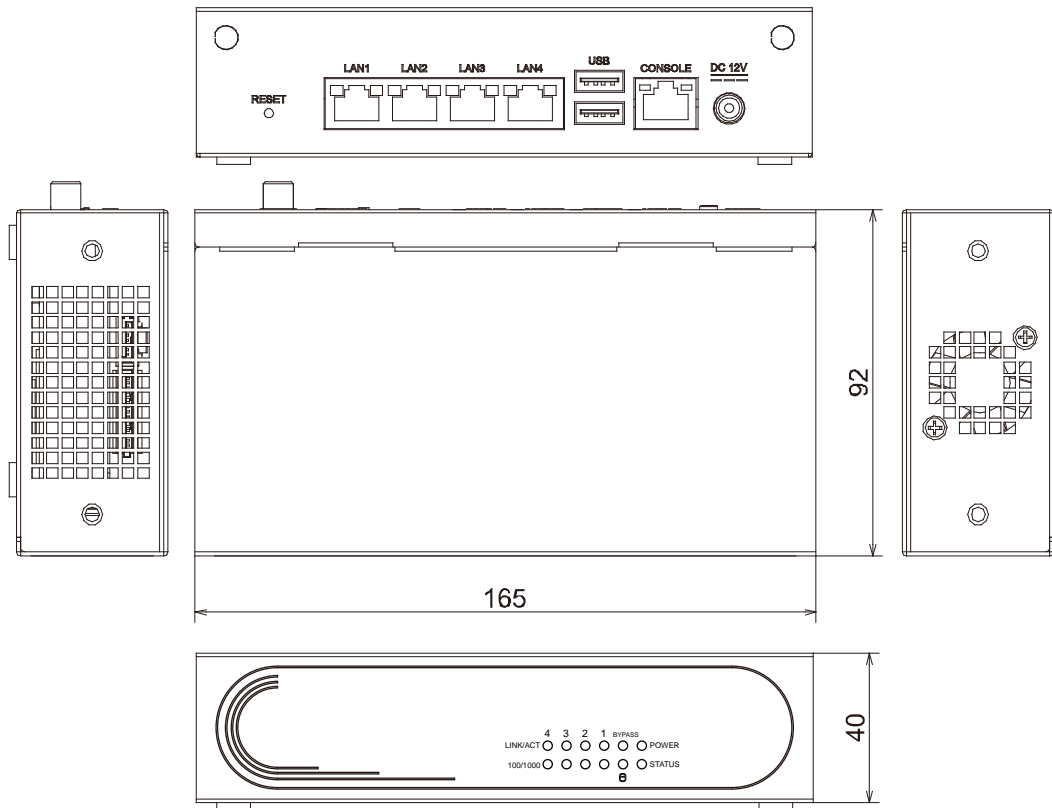

I/O Connectors

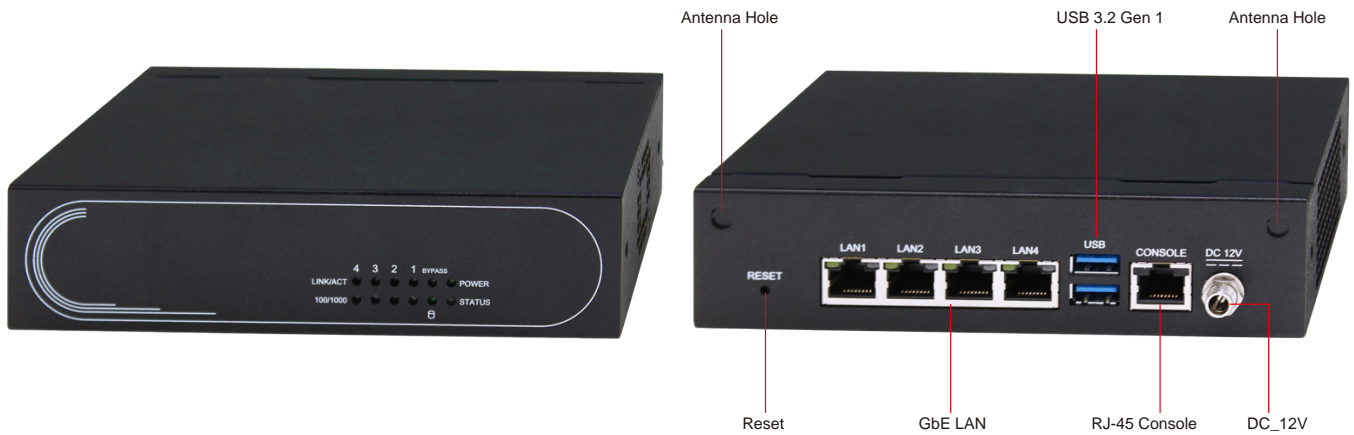

Packing List

- 1 x AND-APL1E-system
- 1 x SATA Cable
- 1 x SATA Power Cable
- 1 x Power Adaptor
- 1 x Power Cord (Option for USA/UK/EU/JPN/AU/RSA)

Ordering Information

AND-APL1E1	Intel Celeron N3350 Dual Core SoC 4x GbE, 1 pair LAN Bypass 2x USB 3.2 Gen1, 1x SATA3,
AND-APL1E2	Intel Atom E3940 Quad Core SoC 4x GbE, 2x USB 3.2 Gen1, 1x SATA3, 1x mPCIe for WiFi or 4G

Embedded Boards

Acrosser's Embedded Boards products include industrial Half-Size card, Type 6 module, Type 7 Module, Type 10 module, AMD COM, and a small form factor COM Express Basic board.

IoT-enabled Automation Solution

Acrosser Embedded Boards can be applied to various industrial applications



Digital Signage



KIOSK



HOME Automation



Industrial

ACM-TGLUE0

Intel Core i COM
Express Type 10 Module

Powerful credit card-sized
55X84mm

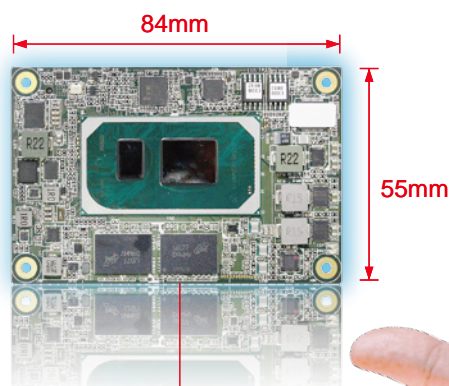

Product Matrix

Embedded Boards



Form Factor	COM Express type 10	COM Express type 10
Model Name	ACM-EL6KE0	ACM-TGLUE0
CPU	Intel Atom® x6000E, Pentium®, Celeron® series Processor	Intel® 11 th Core™ I Processor
Chipset	Intel® SoC	Intel® SoC
Memory	ACM-EL6KE0-A1: Onboard LPDDR4x 4266 memory 8G ACM-EL6KE0-A2: Onboard LPDDR4x 4266 memory 16G	Onboard LPDDR4 4266 memory 16GB In-band ECC supported by SoC
Video Interface	Dual Display : LVDS LCD/eDP, DDI x 1 Single Channel LVDS (18/24 bit)	1 x eDP, 1 x DDI port
SATA	3	2
CF	-	-
Expansion Slot	PCIe [x1] x 4, LPC SMBus, I2C	PCIe [x1] x 4, LPC SMBus, I2C
Ethernet	Intel i226IT 2.5GbE x 1	1 x Intel I225LM GbE Lan, supports PXE Boot
USB	USB 2.0 x 8, USB 3.2 10Gbps x 2	USB 2.0 x 8, USB 3.2 10Gbps x 2
GPIO	8-bit Digital I/O	8-bit Digital I/O
Serial Port	2-Wire UART (Tx/Rx) x 2	2 x COM Interface (TX/RX only)
Audio	High Definition Audio interface	High Definition Audio interface
WatchDog Timer	0 ~ 255 seconds	0 ~ 255 seconds
Hardware Monitor	YES	YES
Page	64	65

Embedded Boards



Form Factor	COM Express type 7	COM Express type 7
Model Name	ACM-ICLDE7	ACM-XD15B7
CPU	Xeon® D, LLC, up to 10c/20t CPU TDP up to 70W	Intel® Xeon® D1548
Chipset	Intel® Xeon D SoC	Intel® Xeon D SoC
Memory	4 x DDR4 SODIMM(Support ECC function) up to 128GB	2 x DDR4-2400MHz, SO-DIMM, up to 32GB Default configuration: 2 x 8GB
Video Interface	-	-
SATA	2	2
CF	-	-
Expansion Slot	24 x PCI-e 3.0 Lanes, 4 x PCI-e 3.0 x2 Lanes	24 x PCI-e 3.0 Lanes, 7 x PCI-e 2.0 Lanes
Ethernet	1 x Intel I210AT GbE Lan, supports PXE Boot	1 x Intel I210AT GbE Lan, 2 x 10 GbE LAN
USB	4 x USB 3.2 Gen1 , 4 x USB 2.0	4 x USB 3.0, 8 x USB 2.0
GPIO	8-bit Digital I/O	8-bit Digital I/O, 4-bit DI and 4-bit DO
Serial Port	2 x COM Interface (TX/RX only)	2 x COM Interface (TX/RX only)
Audio	Intel HD Audio Channel	-
WatchDog Timer	1 ~ 255 seconds	1 ~ 255 seconds
Hardware Monitor	YES	YES
Page	66	67

Product Matrix

Embedded Boards



Form Factor	COM Express type 6
Model Name	ACM-XE21B6
CPU	Intel® Core i7-9850H
Chipset	Intel CM246
Memory	2 x 2666 DDR4 SODIMM up to 64GB, Default configuration: 32GB (2 x 16GB) : ACM-XE21B6 64GB (2 x 32GB) : ACM-XE21B6-64G
Video Interface	3 x DDI/1 x Analogic
E-IDE(44pin) / IDE(40pin)	-
SATA	4
CF	-
Expansion Slot	16 x PCI-e 3.0 Lanes, 8 x PCI-e 2.0 Lanes
Ethernet	-
USB	4 x USB 3.1, 8 x USB 2.0
GPIO	8-bit Digital I/O, 4-bit DI and 4-bit DO
Serial Port	2 x COM Interface (TX/RX only)
Parallel Port	-
Audio	-
WatchDog Timer	0 ~ 255 seconds
Hardware Monitor	YES
Page	68

Embedded Boards



Form Factor	ISA Half-Size
Model Name	AMB-VDX3H2
CPU	Onboard DM&P Vortex86DX3 1GHz,dual core
Chipset	-
Memory	Onboard DDR3 512MB SDRAM
Video Interface	1 x VGA (DB15)
SATA	1
CF	1
Expansion Slot	1 x PC/104,1 x ISA golden finger
Ethernet	1 x RJ45 10/100 Mbps LAN
USB	4 x USB 2.0 (4 x pin header)
GPIO	16-bit Digital I/O
Serial Port	COM1 RS-232 (1 x DB9), COM2 RS-232/422/485 (Pin header)
Audio	-
WatchDog Timer	1 ~ 255 seconds
Hardware Monitor	YES
Page	69

Product Matrix

Embedded Boards



Form Factor	IoT Edge Embedded System
Model Name	AES-EL6KA
CPU	Intel® Celeron® N6210, Dual-Core Intel® Celeron® J6412, Quad-Core
Chipset	Intel® Elkhart Lake SoC
Memory	N6210 On board 4GB J6412 On board 4GB
Video Interface	2 x HDMI 2.0
Expansion Slot	1x M.2 2230 E Key 1x Mini-PCI-e
Ethernet	2 x GbE LAN(RJ45)
USB	2 x USB 3.2Gen1 Type A, 2 x USB 2.0 Type A
GPIO	4 bit GPIO (Reserved)
COM	2 x RS232/422/485
Optional Parts	Power adaptor + Power Code Din Rail Mount Kits Intel Wi-Fi 6E Module Sata & Power cable
WatchDog Timer	1 ~ 255 seconds
Hardware Monitor	YES
Page	70

ACM-EL6KE0

COM Express Type 10 CPU Module with Onboard Intel® Atom™/Celeron®/Pentium® Processor



Features

- Intel Atom® x6000E, Pentium®, Celeron® series Processor
- Onboard Memory LPDDR4, up to 16GB
- Intel i226IT 2.5GbE x 1
- 18/24-bit Single Channel LVDS/eDP, DDI x 1
- SATA3 x 2, Onboard eMMC up to 64GB (Optional)
- USB 2.0 x 8, USB 3.2 10Gbps x 2
- PCIe [x1] x 4
- COM Express Mini Size, Type 10, COM.0 R2.1



Specification

System

CPU	ACM-EL6KE0-A1: Intel® Elkhart Lake Intel Atom(R) x6425E Processor, 2.00GHz up to 3GHz,4C,4T, 1.5MB cache,12W ACM-EL6KE0-A2: Intel® Elkhart Lake Intel Pentium(R) J6426Processor, 2.00GHz up to 3GHz,4C,4T, 1.5MB cache,10W
Chipset	SoC
Memory	ACM-EL6KE0-A1: Onboard LPDDR4x 4266 memory 8G ACM-EL6KE0-A2: Onboard LPDDR4x 4266 memory 16G
BIOS	AMI UEFI
Wake on LAN	Yes
Watchdog Timer	255 Levels
Power Requirement	+12 V and +5 VSB for ATX, +12V for AT
Power Supply Type	AT/ATX
Power Consumption	1.44A@12V, full load, x6425E

Display

Graphic Controller	Intel® UHD Graphics for 10th Gen Intel® Processors
Video Output	Dual Display : LVDS LCD/eDP, DDI x 1 Single Channel LVDS (18/24 bit)

I/O

Ethernet	Intel i226IT 2.5GbE x 1
Audio	High Definition Audio Interface
USB Port	USB 2.0 x 8, USB 3.2 10Gbps x 2
Serial Port	2-Wire UART (Tx/Rx) x 2
HDD Interface	SATA 3 x 2
Expansion Slot	PCIe [x1] x 4 LPC SMBus I2C
GPIO	8-bit
Onboard Storage	Onboard EMMC 64GB
TPM	TPM2.0

Mechanical & Environment

Dimension	13.31" x 2.17" (84mm x 55mm)
Weight	TBD
Operating Temp.	32°F ~ 140°F (0°C ~ 60°C)
Storage Temp	-40°F ~ 185°F (-40°C ~ 85°C)
Relative Humidity	0% ~ 90% relative humidity, non-condensing
Safety	CE/FCC Class A

Packing List

- 1 x ACM-EL6KE0
- 1 x CPU Fan

Ordering Information

ACM-EL6KE0-A1	X6425E, 8GB LPDDR4. 64GB EMMC LVDS.DDI.GbE.SATA.USB3.PCIe RevA1.0
ACM-EL6KE0-A2	J6426, 8GB LPDDR4. 64GB EMMC LVDS.DDI.GbE.SATA.USB3.PCIe RevA1.0

Block Diagram

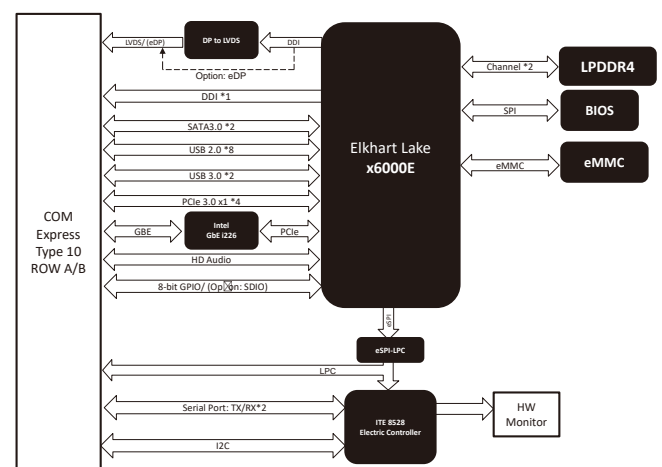

*About the COM-e board, Acrosser can offers consultation for custom carrier board design and planning and also provides low-volume and diverse custom carrier board design, production, manufacturing, and assembly services to help customers who have specific needs for custom carrier boards.

ACM-TGLUE0

Intel Core i COM Express Type 10 Module

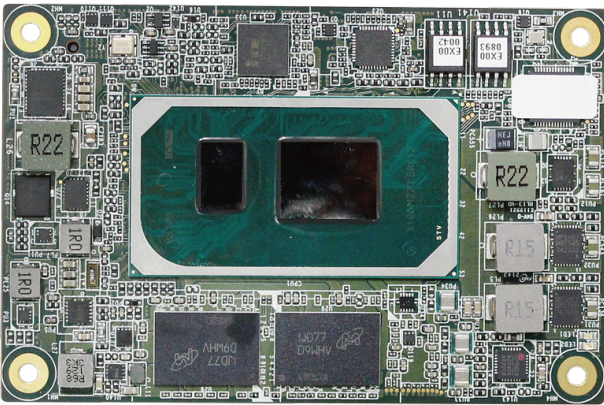

Features

- 11th Generation Intel® Core™ Processor Family (formerly Tiger Lake UP3)
- Onboard LPDDR4x Memory 16 GB
- 2.5 Gigabit Ethernet x 1
- eDP x 1 , DDI x 1
- High Definition Audio Interface
- SATA3.0 x 2 , onboard PCIe SSD 64GB
- USB 2.0 x 8, USB 3.2/2.0 x 2 (up to USB 3.2 Gen 2 support)
- 4 x PCI-Express x 1
- COM Express Type 10, Mini Size, 85 mm x 55 mm

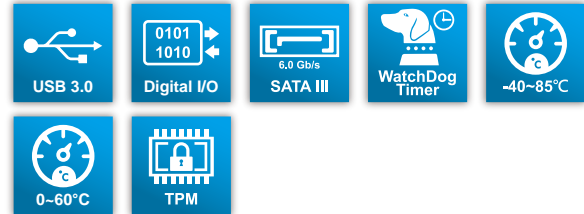

Packing List

- 1 x ACM-TGLUE0
- 1 x CD Title
- 1 x Quick Guide
- CPU cooler.84*55*18 mm.Black.
- Heat Spreader.84x55x11mm.Black.

Ordering Information

ACM-TGLUE0-A0	Intel 11 th core i7-1185GRE(40°C~85°C)
ACM-TGLUE0-A1	Intel 11 th core i7-1185G7E (0°C ~ 60°C)
ACM-TGLUE0-A2	Intel 11 th core i5-1145G7E (0°C ~ 60°C)
ACM-TGLUE0-A3	Intel 11 th core i3-1115G4E (0°C ~ 60°C)

CPU Support

CPU	Core/Thread	Base Frequency/Turbo	TOP	Graphic	In-band ECC	Operating Temp
i7-1185G7E	4/8	1.8GHz/4.4GHz	15W (UP to 28W)	Intel®Iris® Xe Graphics	No	Commercial Temp
i5-1145G7E	4/8	1.5GHz/4.1GHz		Intel®Iris® Xe Graphics	No	Commercial Temp
i3-1115G7E	2/4	2.2GHz/3.9GHz		Intel®UHD Graphics	No	Commercial Temp
i7-1185G7E	4/8	1.8GHz/4.4GHz		Intel®Iris® Xe Graphics	Yes	Embedded/Industrial Extended Temp.
i5-1145G7E	4/8	1.5GHz/4.1GHz		Intel®Iris® Xe Graphics	Yes	Embedded/Industrial Extended Temp.
i3-1115G7E	2/4	2.2GHz/3.9GHz		Intel®UHD Graphics	Yes	Embedded/Industrial Extended Temp.
Celeron 6305E	2/2	1.8GHz/...	15W	Intel®UHD Graphics	No	Commercial Temp

Optional Accessories

- COMe Type 6/10.Carrier Board.ATX.GbE.8USB, 2COM.4SATA.PCIe. AT/ATX.Rev. A1.1

*About the COM-e board, Acrosser can offers consultation for custom carrier board design and planning and also provides low-volume and diverse custom carrier board design, production, manufacturing, and assembly services to help customers who have specific needs for custom carrier boards.

Specification

System

CPU	Intel® 11 th Core™ I Processor
Chipset	SoC
Memory	Onboard LPDDR4 4266 memory 16GB In-band ECC supported by SoC
BIOS	AMI
WatchDog Timer	Software programmable 0~255 sec

Video(Support by Carrier Board)

Graphic Controller	Intel® Irix XE Graphic Intel® UHD Graphics for 11th Gen processor
Video Interface	1 x eDP 1 x DDI port

Storage (Support by Carrier Board)

SATA	2 x SATA III with 6Gb/s
Storage	Onboard PCIe NVMe SSD 64GB

I/O (Support by Carrier Board)

Ethernet Chip	1 x Intel I225LM GbE Lan, supports PXE Boot
Expansion Interface	4 x PCI-e 3.0 Lanes • 4 x PCI-e 3.0 x1
Serial Interface	2 x COM port Interface (TX/RX only)
USB	2 x USB 3.2 Gen2, 8 x USB 2.0
GPIO	8-bit Digital I/O
Audio Codec	High Definition Audio interface

Software

OS Support	Windows 10 / Linux
------------	--------------------

Mechanical & Environment

Dimension	84 mm x 55 mm (3.31" x 2.17") COM Express type 10
Weight	TBD
Operating Temp.	0~60oC (32~140oF)
Storage Temp	-20~70oC (-4~158oF)
Relative Humidity	0 to 90%, non-condensing
Safety	CE, FCC compliant

ACM-ICLDE7

Intel ICE LAKE D COM Express Basic Type 7 Module

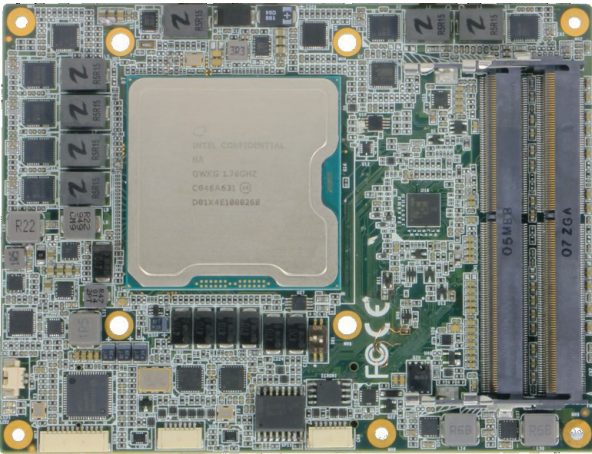

Features

- Intel® SoC XEON™ D LCC series, max TDP 70W
- DDR4 socket x4
- Gigabit Ethernet x 1, 10 GbE x4
- No Display, No Audio
- SATA x 2, USB3.0/2.0 x4
- PEG[x16], 1x PCIe[x8] + 4x PCIe[x2]
- GPIO x8, SMBus, I2C, LPC
- COM Express Basic size, Type 7, 125mmx95mm



Specification

System

CPU	Xeon® D, LLC, up to 10c/20t CPU TDP up to 70W
Chipset	Intel xeon D SoC
Memory	4 x DDR4 SODIMM(Support ECC function) up to 128GB Default configuration: 4 x 32GB
BIOS	AMI
WatchDog Timer	Software programmable 0~255 sec

Storage (Support by Carrier Board)

SATA	• 2 x SATA III with 6Gb/s
------	---------------------------

I/O (Support by Carrier Board)

Ethernet Chip	1 x Intel I210AT GbE Lan, supports PXE Boot
Expansion Interface	24 x PCI-e 3.0 Lanes • 1 x PCI-e 3.0 x16 (or 2 x PCI-e x 8) • 1 x PCI-e 3.0 x 8 4 x PCI-e 3.0 x2 Lanes
Serial Interface	2 x COM port Interface (TX/RX only)
USB	4 x USB 3.2 Gen1 , 4 x USB 2.0
GPIO	8-bit Digital I/O
Audio Codec	Intel HD Audio Channel

Software

OS Support	• Linux Kernel 4.9 & above
------------	----------------------------

Mechanical & Environment

Dimension	125 mm x 95 mm (4.92" x 3.74") COM Express Basic
Weight	TBD
Operating Temp.	0~60oC (32~140oF)
Storage Temp	-20~80oC (-4~176oF)
Relative Humidity	0 to 90%, non-condensing
Safety	CE, FCC compliant

Packing List

- 1 x ACM-ICLDE7
- 1 x CD Title
- 1 x Quick Guide

Ordering Information

ACM-ICLDE7	Intel Xeon D, COM Express Basic Type 7 Module
------------	---

Block Diagram

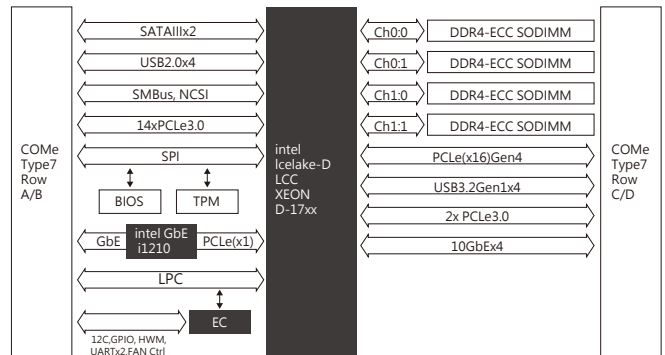

Embedded CPU Chart

ICELAKE-D LCC Sku	CPU Cores	Tcase Temp	TDP	Embedded sku
D-17xxER	10c	0°C~80°C	67W	Yes
D-17xxTR	8c	0°C~80°C	59W	Yes
D-17xxTER	4c	-40°C~80°C	50W	Yes

*About the COM-e board, Acrosser can offers consultation for custom carrier board design and planning and also provides low-volume and diverse custom carrier board design, production, manufacturing, and assembly services to help customers who have specific needs for custom carrier boards.

ACM-XD15B7

Intel Xeon D COM Express Basic Type 7 Module

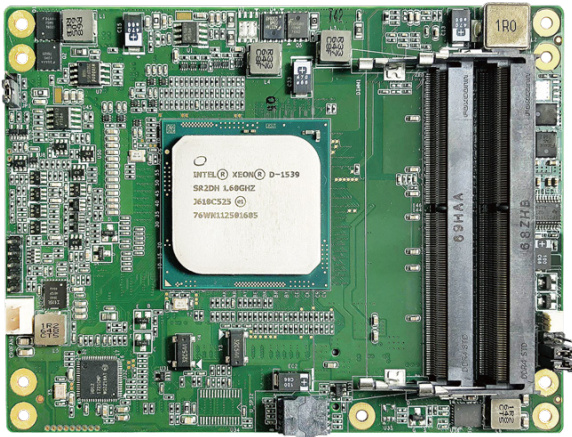

Features

- Newest platform and highest performance
COM Express Basic Type 7
- The Intel Xeon D Processor
- Xeon® D1548 2.0/2.6GHz 12MB(8 core)
- Support Two DDR4 ECC SODIMM , up to 32GB
- 32 PCI-e Lanes
- 2 x 10 GbE KR & NC-SI



Specification

System

CPU	Xeon® D1548 (8 Core, 2.0/2.6GHz, 12MB cache, TDP 45W)
Chipset	Integrated in SoC processor
Memory	2 x 2400 DDR4 SODIMM(Support ECC function) up to 32GB Default configuration: 2 x 8GB
BIOS	AMI
WatchDog Timer	Software programmable 1~255 sec

Storage (Support by Carrier Board)

SATA	• 2 x SATA III with 6Gb/s
------	---------------------------

I/O (Support by Carrier Board)

Ethernet Chip	1 x Intel I210AT GbE Lan, supports PXE Boot 2 x 10 GbE with KR interface & NC-SI
Expansion Interface	24 x PCI-e 3.0 Lanes • 1 x PCI-e 3.0 x16 (or 2 x PCI-e x 8) • 1 x PCI-e 3.0 x 8 7 x PCI-e 2.0 Lanes • 6 x PCI-e 2.0 x1(AB connector) • 1 x PCI-e 2.0 x1(CD connector)
Serial Interface	2 x COM port Interface (TX/RX only)
USB	4 x USB 3.0, 8 x USB 2.0
GPIO	8-bit Digital I/O, 4-bit DI and 4-bit DO
Audio Codec	Intel HD Audio Channel

Software

OS Support	• Linux Kernel 4.9 & above
------------	----------------------------

Mechanical & Environment

Dimension	125 mm x 95 mm (4.92" x 3.74") COM Express Basic
Weight	TBD
Operating Temp.	0~60°C (32~140°F)
Storage Temp.	-20~80°C (-4~176°F)
Relative Humidity	0 to 90%, non-condensing
Safety	CE, FCC compliant

Packing List

- 1 x ACM-XD15B7
- 1 x CD Title
- 1 x Quick Guide

Ordering Information

ACM-XD15B7	Intel Xeon D 1548 , COM Express Basic Type 7 Module
------------	---

Dimension

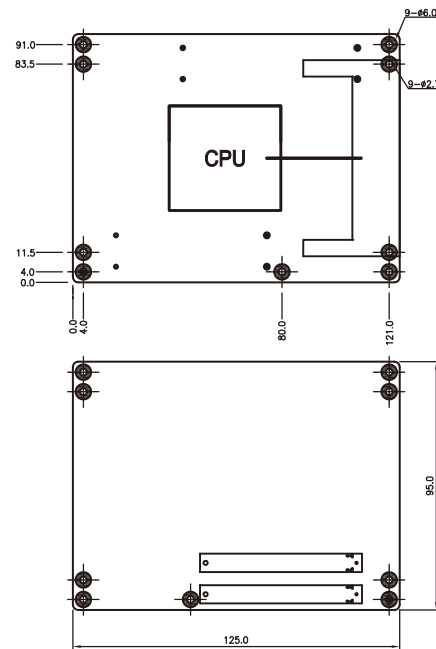

*About the COM-e board, Acrosser can offers consultation for custom carrier board design and planning and also provides low-volume and diverse custom carrier board design, production, manufacturing, and assembly services to help customers who have specific needs for custom carrier boards.

ACM-XE21B6

Intel Core i7 COM Express Basic Type 6 Module

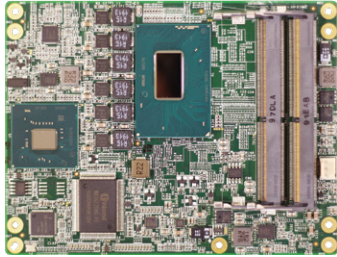

Features

- Newest platform and highest performance COM Express Basic Type 6
- The Intel CM246 Chipset
- Intel® Core™ i7- 9850HE Processor, 9M Cache, 2.7GHz / , 4.4GHz
- Support Two DDR4 SODIMM , up to 64GB
- 24 PCI-e Lanes
- 1x GbE

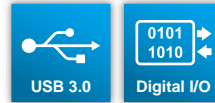

Specification

System

CPU	Intel® Core™ i7-9850HE Processor (9M Core, 2.7GHz, 4.4GHz)
Chipset	Intel CM246
Memory	2 x 2666 DDR4 SODIMM up to 64GB, Default configuration: 32GB (2 x 16GB) : ACM-XE21B6 64GB (2 x 32GB) : ACM-XE21B6 64G
BIOS	AMI
WatchDog Timer	Software programmable 0~255 sec

Video(Support by Carrier Board)

Graphic Controller	Intel® UHD Graphics 630
Video Interface	1 x Analogic RGB Display Output,supports max resolution 2048 x 1536@75Hz 3 x DDI Port Output,supports max resolution up to 4096x2304@60Hz

Storage (Support by Carrier Board)

SATA	• 4 x SATA III with 6Gb/s
------	---------------------------

I/O (Support by Carrier Board)

Ethernet Chip	1 x Intel I210AT GbE Lan, supports PXE Boot
Expansion Interface	16 x PCI-e 3.0 Lanes • 1 x PCI-e 3.0 x16 (or 2 x PCI-e x 8)Select by Bios setting 8 x PCI-e 2.0 Lanes • 6 x PCI-e 2.0 x1(AB connector) • 2 x PCI-e 2.0 x1(CD connector)
Serial Interface	2 x COM port Interface (TX/RX only)
USB	4 x USB 3.1, 8 x USB 2.0
GPIO	8-bit Digital I/O, 4-bit DI and 4-bit DO
Audio Codec	Intel High Definition Audio

Software

OS Support	• Linux Kernel 4.14 & above
------------	-----------------------------

Mechanical & Environment

Dimension	125 mm x 95 mm (4.92" x 3.74") COM Express Basic
Weight	TBD
Operating Temp.	0~60°C (32~140°F)
Storage Temp.	-20~80°C (-4~176°F)
Relative Humidity	0 to 90%, non-condensing
Safety	CE, FCC compliant

Packing List

- 1 x ACM-XE21B6
- 1 x CD Title
- 1 x Quick Guide

Ordering Information

ACM-XE21B6	Intel core i7 9850HE , COM Express Basic Type 6 Module with 32GB DDR4 Memory
ACM-XE21B6 64G	Intel core i7 9850HE , COM Express Basic Type 6 Module with 64GB DDR4 Memory

Dimension

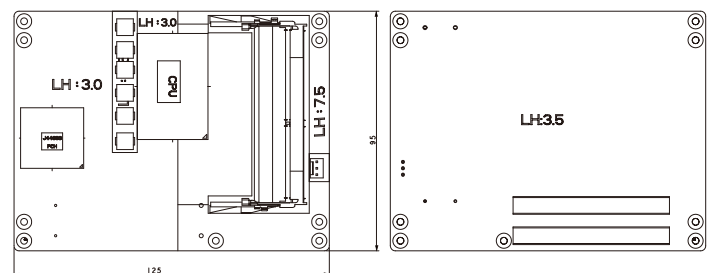

*About the COM-e board, Acrosser can offers consultation for custom carrier board design and planning and also provides low-volume and diverse custom carrier board design, production, manufacturing, and assembly services to help customers who have specific needs for custom carrier boards.

AMB-VDX3H2

Fanless ISA Bus DM&P Vortex86DX3 Dual core 1GHz SBC

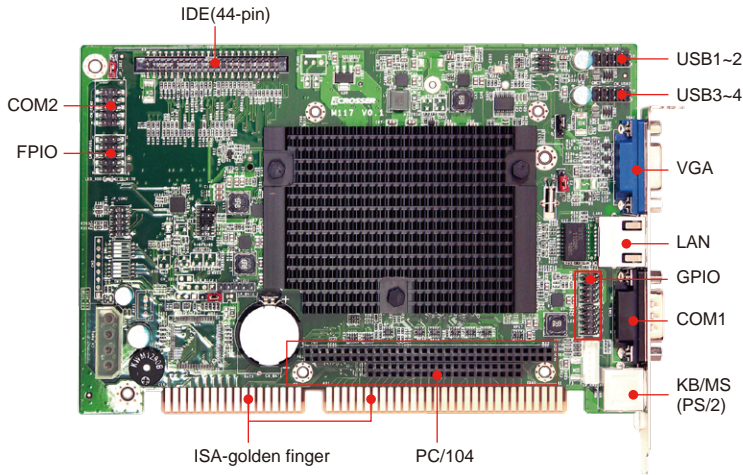

Features

- Fanless Design
- Onboard DM&P Vortex86DX3 1GHz dual core
- Onboard 512GB DDR3 SDRAM
- IDE, CF,msata(Reserved)
- PC/104 & ISA Interface
- 2 x COM, 4 x USB 2.0, VGA, 1 xRJ45 10/100 Mbps LAN



Specification

System

CPU	Onboard DM&P Vortex86DX3 1GHz,
Memory	Onboard DDR3 512MB SDRAM
BIOS	AMI
WatchDog Timer	Software programmable 0~255 sec.(0=disable)

Video

Graphic Controller	Integrated
Video Memory	shared with main memory(16/32MB)
Video Interface	1 x VGA (DB15)

Storage

IDE	1 x IDE (44-pin)
SATA	1 x msata(Reserved)
CF	1 x CF Card

I/O

Ethernet	1 x RJ45 10/100 Mbps LAN
Expansion Slot	1 x PC/104,1 x ISA golden finger
Serial Port	<ul style="list-style-type: none"> • COM1 RS-232 (1 x DB9) • COM2 RS-232/422/485 (Pin header)
USB	4 x USB 2.0 (4 x pin header)
GPIO	16-bit Digital I/O
SRAM	512K (Reserved)
Keyboard/Mouse	<ul style="list-style-type: none"> • 1 x PS/2 • 1 x JST
FPIO	1 x FPIO

Power Requirement

Power Input	AT:5V + 12V input
-------------	-------------------

Software

OS Support	Windows XP, Windows Embedded CE 6.0, Windows 7 (32 bits),DOS
------------	--

Mechanical & Environment

Dimension	185mm x 122mm (7.29" x 4.81")
Operating Temp.	0~60°C (32~140°F)
Storage Temp.	-20~80°C (-4~176°F)
Relative Humidity	0 to 90% @40°C, non-condensing
Safety	CE, FCC compliant

Packing List

- 1 x AMB-VDX3H2
- 1 x Quick user guide

Ordering Information

AMB-VDX3H2A	1 x AMB-VDX3H2A (1GHz CPU/512MB Memory, 1 x RS232/ 1 x RS232/RS422/RS485) CF+IDE 1 x Quick User Guide
AMB-VDX3H2A1	1 x AMB-VDX3H2A1 (1GHz CPU/512MB Memory, 1 x RS232/ 1 x RS232/RS422/RS485) CF+mSata 1 x Quick User Guide 1 x Utility CD
accessory	ACC-VDX3H2: 1 x 44-pin IDE cable 1 x DB9 cable w/bracket 1 x 2 port USB cable w/bracket 1 x KB/MS Y-cable

AES-EL6KA

Intel Elkhart Lake System



Features

- Onboard LPDDR4 Memory 4GB
- Onboard eMMC Storage up to 64GB
- Dual HDMI 2.0 displays up to 4K at 60Hz
- Dual RJ45 GbE Lan
- 2 x USB 3.2 Gen1, 2 x USB2.0
- 2 x RS232/422/485
- TPM 2.0
- Fan-Less design

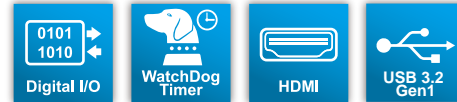

Specification

System

CPU	A1: Intel® Celeron® N6210, Dual -Core, 1.5M Cache, 1.2GHz (2.6GHz), 6.5W A2: Intel® Celeron® J6412, Quad-Core, 1.5M Cache, 2GHz (2.6GHz), 10W
Chipset	Intel Elkhart Lake SoC
Memory	N6210 On board 4GB J6412 On board 4GB
BIOS	AMI UEFI BIOS

Video

Graphic Controller	Intel® Gen10 UHD Graphics
Video Memory	Shared Memory
Video Interface	2 x HDMI 2.0

Storage

Storage	A1: On board 32GB A2: On board 64GB
---------	--

I/O

Ethernet	2 x GbE LAN (RJ45)
Expansion Slot	1x M.2 2230 E Key 1x Mini-PCI-e
USB	2 x USB 3.2 Gen1 Type A, 2 x USB 2.0 Type A,
GPIO	4 bit GPIO (Reserved)
COM	2 x RS232/422/485
Optional Parts	Power adaptor + Power Code Din Rail Mount Kits Intel Wi-Fi 6E Module Sata & Power cable

Power Requirement

Power Input	12V DC in
-------------	-----------

Software

OS Support	Windows 10 Full,, Windows IOT Kernel 4.8, Ubuntu 22.04
------------	---

Mechanical & Environment

Dimension	140 x 90 x 45mm
Operating Temp.	0~60°C
Safety	RoHS

Dimensions

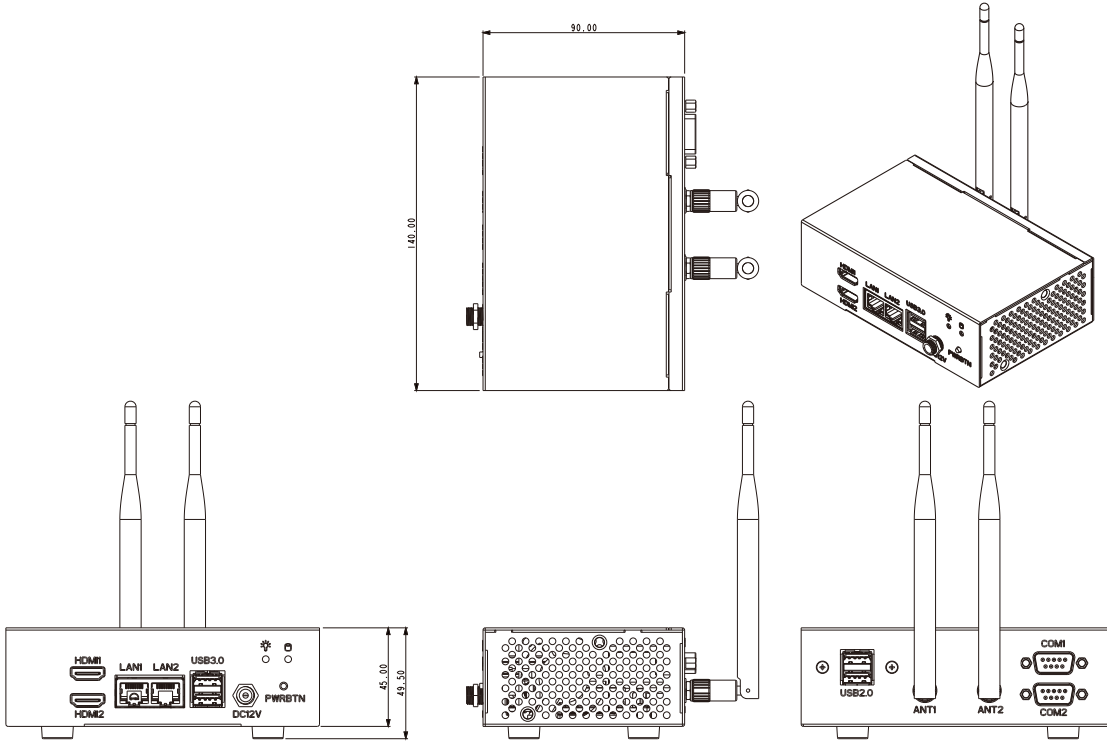

I/O Connectors

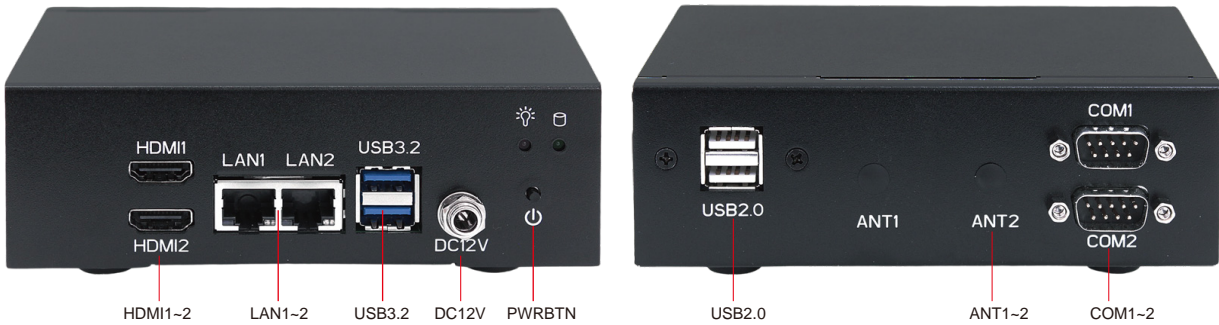

Optional items

- Power Adapter.12V.+ power cord x 1
- DIN-Rail Mount Kit x 1
- Intel Wi-Fi 6E AX210NGW + 2 x Antenna + Cables x 1
- Sata & power cable x 1

Ordering Information

- | | |
|------------|---|
| AES-EL6KA1 | N6210.2HDMI+ Fanless design
4GB LPDDR4 .2LAN.2COM.4USB.32G eMMC.
mSATA.M.2 2230 E. |
| AES-EL6KA2 | J6412.2HDMI+ Fanless design
4GB LPDDR4 .2LAN.2COM.4USB.64GB eMMC.
mSATA.M.2 2230 E. |



To Make Your
Embedded
Idea a Reality



Acrosser Headquarters

新北市三重區重新路5段609巷4號3樓之8
Rm. 8, 3F., No. 4, Ln. 609, Sec. 5, Chongxin Rd.,
Sanchong Dist., New Taipei City 241402, Taiwan
TEL: +886-2-29999000
FAX: +886-2-29992887

Acrosser Taichung Office

40858台中市南屯區保安八街28號3樓之1
3F.-1, No. 28, Bao'an 8th St., Nantun Dist.,
Taichung City 40858, Taiwan
TEL: +886-4-23370715
FAX: +886-4-23373422

Acrosser USA Inc.

324 W. Blueridge Avenue,
Orange CA 92865
TEL: (714)728-6964

Acrosser China Subsidiary

深圳市欣扬通电子有限公司
深圳市福田区泰然八路安华工业区4栋5层505室 (邮编:518040)
Room 505, Floor 5, Building 4, Anhua Industrial Zone, Tairan 8th Road,
Futian District, Shenzhen, China (Postal:518040)
TEL: +86-755-83542210
FAX: +86-755-83700087